

# **Eventide H9000 User's Manual**

## **Software Version 1.0**

Part No: 141242

©2017 Eventide Inc., One Alsan Way, Little Ferry, NJ, 07643 USA

## Table of Contents

<b>INTRODUCTION .....</b>	<b>4</b>
A NOTE ON THE USER INTERFACE.....	4
WHAT'S IN THE BOX .....	4
H9000 FEATURES .....	5
TERMINOLOGY.....	6
<b>PRESETS.....</b>	<b>8</b>
<b>H9000 HARDWARE.....</b>	<b>10</b>
STANDARD FRONT PANEL.....	10
REAR PANEL .....	14
<b>OPERATING THE H9000 .....</b>	<b>18</b>
A NOTE ON "LATCHING" SOFT KEYS:.....	18
THINGS TO KNOW ABOUT SIGNAL ROUTING .....	19
SESSIONS.....	20
FX CHAINS.....	23
<i>Direct I/O.....</i>	<i>26</i>
<i>The FX Chain Preset Browser .....</i>	<i>27</i>
<i>Mix.....</i>	<i>28</i>
<i>Levels .....</i>	<i>29</i>
ALGORITHMS .....	30
<i>Algorithms Overview.....</i>	<i>30</i>
<i>Algorithm Selection Screen .....</i>	<i>35</i>
PARAMETERS.....	39
<i>Editing Parameters in an Algorithm.....</i>	<i>40</i>
<i>Functions.....</i>	<i>44</i>
METERS.....	47
SAVING AND IMPORTING DATA.....	50
<i>Saving.....</i>	<i>50</i>
<i>Importing Data.....</i>	<i>52</i>
SCENES .....	53
<i>Overview.....</i>	<i>53</i>
<i>Trigger Source Options .....</i>	<i>54</i>
<i>Working with Scenes.....</i>	<i>55</i>
<b>SETUP .....</b>	<b>59</b>
INFO .....	60
NAME.....	61
CLOCK.....	62
TEMPO .....	64
PREFERENCES.....	66
PEDALS.....	68
ANALOG REFS.....	70
NETWORK.....	71
<i>Ethernet Setup.....</i>	<i>71</i>
<i>Wireless Setup .....</i>	<i>72</i>
<i>Creating a Local Access Point .....</i>	<i>73</i>
SOFTWARE UPDATE.....	74

<b>USING THE H9000 AS A COMPUTER AUDIO INTERFACE .....</b>	<b>76</b>
USING THE H9000 WITH OS X .....	77
<i>Using the H9000 With Your Existing Computer Audio Interface .....</i>	<i>77</i>
<b>APPENDICES.....</b>	<b>79</b>
APPENDIX A: SIGNAL FLOW .....	79
APPENDIX B: STARTUP SEQUENCES .....	81
APPENDIX C: WORD CLOCK TERMINATION IN THE H9000.....	82
APPENDIX D: H9000 MIDI FUNCTIONALITY .....	83
APPENDIX E: H9000 PRESETS.....	84
APPENDIX F: H9000 ALGORITHMS .....	104
<b>SAFETY INFORMATION .....</b>	<b>140</b>
<b>LIMITED WARRANTY .....</b>	<b>141</b>

## Introduction

Congratulations on your purchase of the Eventide H9000, the new flagship processor in the Eventide product line.

The H9000 is designed to be an incredibly versatile tool, allowing you to process a large number of channels using the latest digital and networked audio formats, and offering the great sounding effects you have always loved from Eventide.

The H9000 is available in two basic models:

- The H9000 Standard: Full set of front panel controls and a color display.
- The H9000R: Blank front panel. Requires Emote remote control software.

Both versions of the H9000 accept a range of expansion boards that support industry standard protocols for digital and networked audio I/O.

### A Note on the User Interface

The standard H9000 comes with a front-panel color display and a large complement of hardware controls, allowing you to navigate the device with ease. However, we highly encourage you to download and use the full-featured control app/plug-in “Emote”, available as a free download at [www.eventideaudio.com/emote](http://www.eventideaudio.com/emote). Emote is required to control the blank front panel model, H9000R.

Emote is available as a stand-alone program for Windows and OS X computers, as well as a plug-in for VST, AU and Pro Tools. Emote gives you control of all features and settings of your H9000, allowing you to craft your effects extremely quickly and intuitively. Think of Emote as your artistic partner, letting you dig deeper into the creative potential of the H9000.

### What’s In The Box

Your H9000/H9000R comes with the following contents:

- H9000/H9000R 2RU Rack Mount processor
- Rack Mount Screws
- User’s Manual
- Registration/Warranty Card
- Wireless Network (WIFI) Dongle
- Power Cable
- USB Cable

## **H9000 Features**

The H9000 is designed to be easy to use while still giving you a large amount of power, control and versatility through the implementation of the following features:

### **Multiple Quad ARM Processors**

The H9000 uses multiple cutting-edge effects processors, allowing it to process a large number of I/O channels and up to 16 separate effects algorithms simultaneously.

### **Flexible and Adaptable Effects Structure**

Your H9000 can utilize up to 4 separate FX Chains, with each chain containing up to 4 separate processing algorithms. The FX Chains can be routed in series, parallel, and more.

### **Large Complement of Analog and Digital Input / Output**

Multiple formats and connector types allow you to easily integrate the H9000 into a variety of setups.

### **Expandable I/O**

Three option card slots allow you to integrate your H9000 into the latest digital audio and networked audio environments. We are always developing new option cards, ensuring that your processor is as future-proof as possible in the always-evolving world of digital and networked audio formats.

### **Full Front Panel Control**

While we offer the extremely useful Emote control app, the standard H9000 also provides intuitive front panel control using a large color display, context sensitive soft keys, and a large complement of physical navigation controls.

### **Network Connectivity**

Connect the H9000 to your Local Area Network for quick and easy software updates, as well as full control through our Emote software.

### **Computer Audio Interfacing**

USB 2.0 allows you to interface your H9000 with your audio software as a standard audio interface with 16 channels of I/O. Send, process, and return 16 separate channels of individual DAW tracks.

### **Easy Sharing of FX Chains and Sessions**

The H9000 uses standard, “off-the-shelf” USB thumb drives to save and import your custom effects settings, making it easy to back up, carry, and share your creative efforts.

## Terminology

In order to get the most out of your H9000, please familiarize yourself with the four main terms below which represent the “hierarchy” used in the product:

- Algorithm
- Parameters
- FX Chain
- Session

### Algorithm

Over many years, Eventide has created a vast library of audio processing routines, which exist as effects processing “modules”. Some of these are simple, such as a low pass filter, a limiter, a compressor, etc., while others are more complex, such as an FFT or a reverb network.

An *Algorithm* in the H9000 is a combination of some of these modules, and of certain variable values associated with the modules that make up that algorithm. The designer of the algorithm might choose to set some variables of some modules to a specific value that cannot be changed by the user, while at the same time allowing that user to change the values of other variables.

Simply put, the algorithms are the H9000’s “secret sauce”, with specific effects parameters that are adjustable by you, the user.

### Parameters

*Parameters* are the individual adjustments you can make within an effects algorithm which customize that effect. On the H9000, when you navigate to a specific algorithm you are presented with that algorithm’s specific parameters, which you can easily adjust.

A parameter might control one variable of one underlying processing module, or it may control several variables of several modules. Some parameters may be adjustable, whereas for others the designer may choose to set some of the underlying variables to a fixed value and not “bring them out” to the user of the effect.

For example, a reverb algorithm would present you with settings such as reverb time, room size, decay time, etc. In contrast, a guitar amp emulator might offer parameters such as gain amount, low/mid/high EQ, etc.

## FX Chain

The H9000 allows you to chain up to 4 separate algorithms together into a custom *FX Chain*. The FX Chain is fed by an audio input, then the audio is routed through up to 4 algorithms, and then finally to an audio output.

You are free to decide which algorithms are included in the FX Chain, the order they process the audio in, and even determine aspects such as separate parallel and series audio paths.

## Sessions

A *Session* is the highest level on the H9000 hierarchy. It saves the entire state of the product at any given moment, including:

- The currently loaded FX Chains (up to all 4)
- The current settings for the parameters within the FX Chains
- The current input/output assignments to and from the FX Chains
- The current state of the assorted global settings

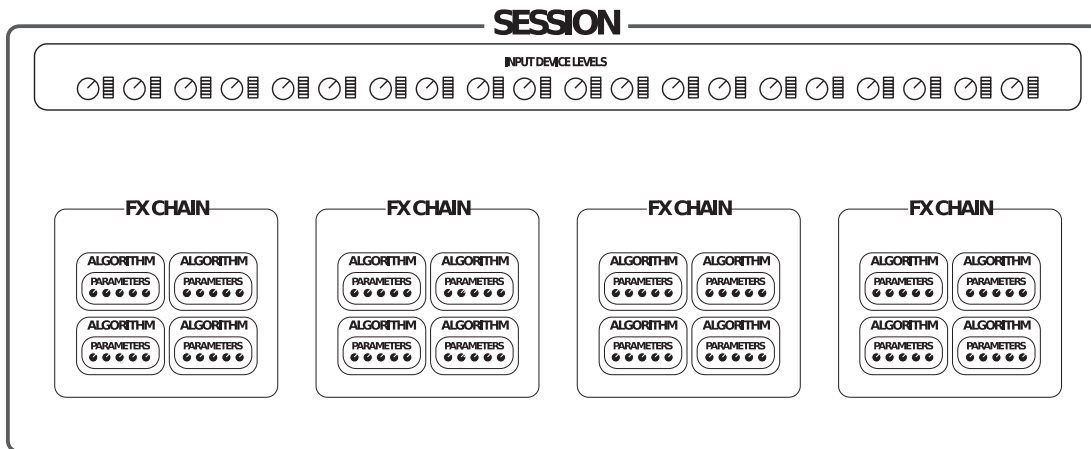

The standard H9000's front panel contains dedicated hardware buttons for all four of the above modes, making it quick and easy to access any level of the hierarchy at the touch of a button.

## Presets

The term “preset” is perhaps overused in our industry, so we would like to clarify how this term is used by the H9000. The H9000 supports 3 types of presets, each corresponding to the top 3 levels of the hierarchy. You can save and load:

### Algorithm Presets

An algorithm preset contains:

- Algorithm-related parameter values
- General parameter values related to the algorithm container (mix, mute/bypass, input/output gains)
- Mappings of parameters to external controllers and Functions (can be excluded at load time)
- Assorted metadata (Name and ID are the most relevant to the user)

### FX Chain Presets

An FX Chain presets contains:

- Everything contained within an algorithm preset, for all the algorithms present in the FX chain
- General parameter values related to the entire FX chain container (mix, mute/bypass, input/output gains)
- Additional mappings of these general FX Chain parameters to MIDI controllers
- All routing information internal to the FX Chain (from the FX chain inputs, to/between algorithm containers, to the FX chain outputs). No Physical I/O information is included.
- Function values, as well as mappings of the actual Function knobs to external controllers
- Metadata (Name and ID are the most relevant to the user)



## Sessions

Sessions contain:

- Everything contained within an FX chain preset, for all the FX chains present on the device
- Routing information external to each FX chain, including:
  - Physical I/O in and out of each FX chain container
  - Direct I/O connections made between Physical I/O
- Additional input/output gain settings for each I/O channel routed to/from the FX chain
- All the settings found in the Setup mode (these can be excluded by category when loading)
- All the Scene Maps found in Scenes mode, along with current active map index
- LED meter mappings
- The state of Global Mute/Bypass
- Metadata (Name and ID are the most relevant to the user)

# H9000 Hardware

## Standard Front Panel

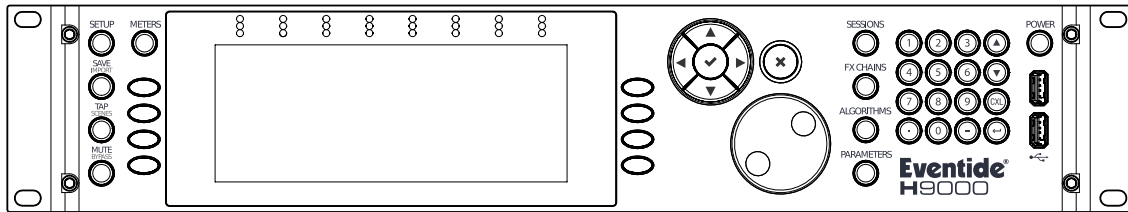

The H9000 has a full set of front panel controls, allowing for quick and easy control of all of its features.

Note that the color display on the front panel is *not* a touchscreen. However, eight dedicated “soft keys” are available, with their specific function always tied to a specific, context sensitive adjustment located adjacent to them on the screen.

By using the soft keys in conjunction with the large cursor diamond and jog wheel, all adjustments to the H9000 are readily available.

If you prefer to install the H9000 in a location where working with the front panel is not practical or convenient, note that all adjustments can also be made using our Emote software.

The H9000 front panel contains the following controls; please refer to the relevant sections of the user’s manual for further details on each function.

### Setup

Press the *Setup* button to enter the setup menu, where you can configure assorted preferences for your device.

### Save/Import

Press the *Save/Import* button to save the different types of presets to internal memory, as well as optionally saving to an attached USB drive.

Long-press the *Save/Import* button to import saved presets into the H9000. See the section “Saving and Importing” for more details.

### Tap/Scenes

Press the *Tap* button multiple times to set a tempo (measured in beats per minute, or “BPM”). This tempo setting will be used as a sync reference for time based effects such as digital delay.

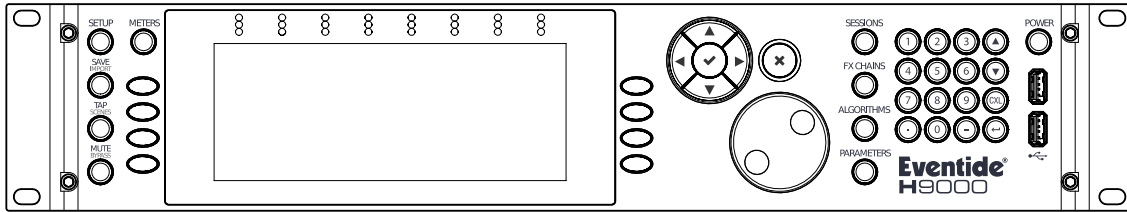

The *Tap* button's inset LED illuminates in time with the tempo you have set, giving a visual indication of the tempo itself. Note that if you're not a fan of constant flashing, this can be disabled in the *Setup* menu.)

Long-press the tap/scenes button in order to create a scene; a naming screen will come up to allow you to create a name for the scene.

See the section "Creating Scenes" for more details.

### **Mute/Bypass**

Press the *Mute/Bypass* button in order to mute the audio output of the H9000.

Long-press the *Mute/Bypass* button in order to bypass any and all processing while still preserving the flow of audio through the I/O connectors and FX chains.

When either Global Mute or Global Bypass is activated, an indicator will show in the upper right hand corner until deactivated.

### **Meters**

Press the *Meters* button to switch the display to a full-fledged meter bridge. A wide variety of metering choices are available.

### **Soft Keys**

These 8 unlabeled buttons (four on either side of the display) allow you to quickly navigate the H9000's front panel user interface. The soft keys correspond to different functions that are displayed adjacently, and are always context sensitive to the currently displayed screen.

### **Color Display**

The H9000's large color display allows you to both view and control all aspects of the product while working with its front panel controls.

### **8-Channel Meters**

These 3-segment hardware meters display metering information for the H9000 and are active at all times.

### **Cursor Diamond**

Use the 4 keys of the cursor diamond to navigate up, down, left and right. The color display will always highlight the object that you have navigated to with the cursor diamond.

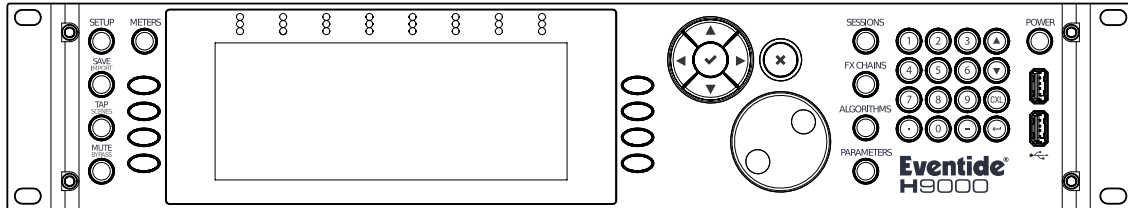

### **Enter (✓)**

Press the *Enter* (check mark) button to confirm or complete an action that you are currently performing; for example, if you have used the cursor diamond to highlight an object, pressing the *Enter* button will select that object. The color display offers a pop-up window to let you know when the *Enter* button can be used.

### **Cancel (X)**

Press the *Cancel* (X) button to “cancel out of” an action. As with the *Enter* button, the color display offers a pop-up window to let you know when the *Cancel* button can be used.

### **Jog Wheel**

The large, heavily weighted jog wheel is used to both navigate around the display, as well as adjust a currently highlighted setting. For example, if adjusting a room size parameter in a reverb algorithm, you can spin the wheel to comfortably adjust the specific parameter value.

### **Mode Buttons**

The H9000 has 4 dedicated Mode buttons that let you switch to any of the editing modes with a single touch:

- Sessions
- FX Chains
- Algorithms
- Parameters

The mode button illuminates to remind you which mode you are currently in, at any given time.

### **Power**

Press the latching power button to turn the H9000 on or off.

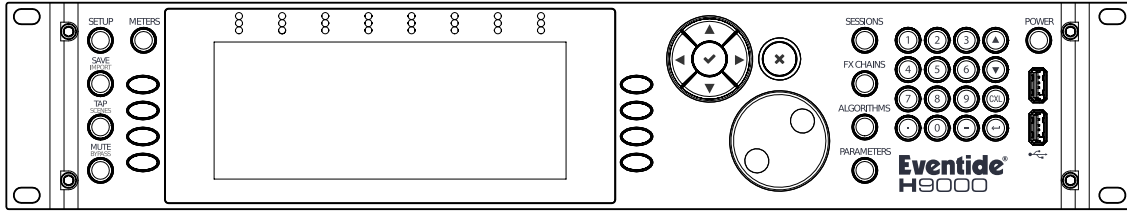

## USB Ports

The front panel USB ports provide three separate functions:

- Connect a standard USB thumb drive or hard drive to either of the front/rear panel USB ports to save or import any H9000 presets you have created.
- Attach the included USB Wi-Fi dongle to connect the H9000 to a local area network
- Connect a class-compliant USB MIDI controller for real-time adjustment of assorted H9000 functions

## Number Pad

Use the buttons on the number pad to type in a custom name, for any naming screen you are presented with.

The number buttons operate “vintage mobile phone” style, where each button cycles through multiple letters and also offers special characters such as “.” and “-”.

## Up/Down Arrows

The up/down arrows act as modifier keys for the number pad when naming an object, allowing you to switch between upper and lower case characters as well as enter in different symbols.

You can also use the arrow keys to fine-tune parameter values, as well as scroll through list items.

## Cancel (CXL)

Press the CXL button to cancel (delete) a character you have typed when creating a custom name.

Long press the CXL button to clear the entire text field.

## Back

Press the back arrow to move the cursor backwards within a naming field, allowing you to make corrections to an existing name you are typing.

## Rear Panel

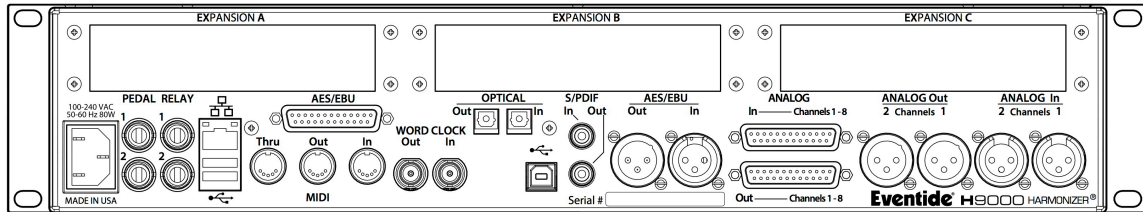

The H9000's rear panel offers a wide variety of audio and data connections, allowing it to be used in many different environments and workflows.

### Power Connector

Connect your H9000 to your power source using a standard IEC power cable. The H9000's power supply is designed to work with a wide variety of international voltages; your unit will ship with a power cable designed to work in your territory.

### Pedal (x2)

The H9000 allows you to connect 2 separate foot pedals, which you can then assign to different functions of the processor. This ability is useful in a live performance situation.

### Relay (x2)

The dual ¼" relay connectors allow H9000 actions to be completed using standard relay signals.

**Note:** In the current 1.0 Firmware, the relay connectors on the H9000 are not yet operational. Please check back at [www.eventideaudio.com](http://www.eventideaudio.com) for details of a future software update that will enable their operation.

### Ethernet Connector

The H9000's standard RJ-45 connector allows you to connect it to your Local Area Network (LAN).

Once connected, you can view and control the H9000's operations using Emote. Additionally, if your LAN has Internet access, your H9000 can connect to Eventide's servers to install software/firmware updates.

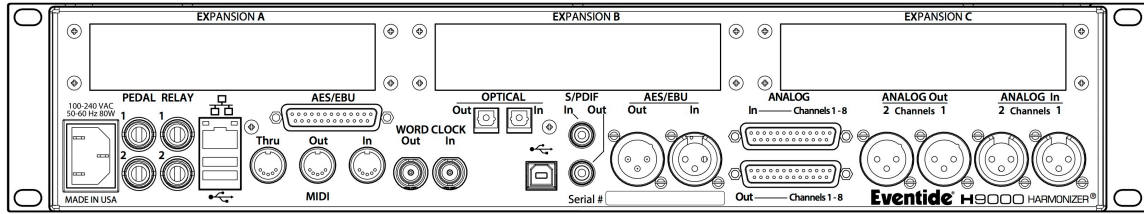

### USB A Connector

The rear panel USB ports provide the exact same functions as the front panel ports:

- Connect a standard USB thumb drive or hard drive to either of the rear panel USB ports to save or import any H9000 presets you have created.
- Attach the included USB Wi-Fi dongle to connect the H9000 to a local area network
- Connect a class-compliant USB MIDI controller

### USB B Connector

Connect the H9000 to your Mac or PC, allowing you to use it as a 16-input, 16-output computer audio interface.

### AES/EBU Connector

This connector allows you to feed the H9000 with 8 channels of AES-EBU digital audio, and also allows the unit to output 8 channels, all on the same single DSUB connector.

### AES/EBU 2-channel Input

This XLR input accepts a standard 2-channel AES/EBU digital audio signal.

### AES/EBU 2-channel Output

This connector outputs 2 channels of audio in the AES/EBU digital audio format at whatever sample rate the system is currently set to.

### S/PDIF Input

This input accepts a standard 2-channel S/P DIF digital audio signal.

### S/PDIF Output

This connector outputs 2 channels of audio in the S/P DIF digital audio format at whatever sample rate the system is currently set to.

**Note:** The H9000's digital audio connectors support the following sample rates:

- 44.1kHz
- 48kHz
- 88.2kHz
- 96kHz

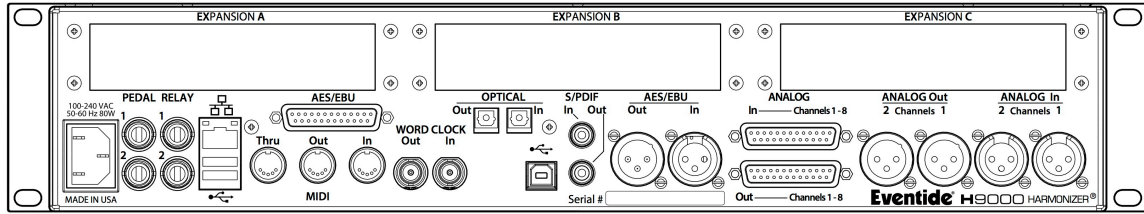

### Analog Input 8-channel

This connector feeds the H9000 with 8 channels of balanced analog audio input.

### Analog Output 8-channel

This connector outputs 8 channels of balanced analog audio.

**Note:** You can adjust the operating level of the 8-channel analog inputs and outputs in the *Setup* menu, between +4dBu and -10dBv. Levels can be set independently for each stereo pair of analog inputs and outputs.

### Analog Input 2-Channel

These dual balanced XLR connectors accept two channels of balanced analog audio.

### Analog Output 2-Channel

These balanced XLR connectors output two channels of balanced analog audio.

### MIDI Input

The MIDI input allows you to control various H9000 parameters with incoming MIDI messages, using MIDI controller hardware or MIDI software of your choosing. The MIDI input also allows you to synchronize the H9000's time-based effects to an incoming MIDI clock signal.

### MIDI Output

The MIDI Out connector outputs a MIDI clock signal, allowing you to synchronize other equipment with the internal tempo set for your unit.

### MIDI THRU

The MIDI THRU connector accepts any incoming MIDI signals and outputs a mirrored duplicate of those signals. This allows you to daisy chain multiple MIDI devices when you do not have enough MIDI ports on your standalone MIDI interface.

### Word Clock Input

This connector allows the H9000 to slave its digital system clock to an incoming word clock signal. It is compatible with word clock signals ranging in sample rate from 44.1kHz to 96kHz.



**Work Clock Output**

This connector outputs the H9000's digital clock signal at the unit's currently configured sample rate.

**Optical Input**

The H9000's optical input accepts an 8-channel ADAT signal.

**Optical Output**

The optical output sends 8 channels of ADAT format digital audio.

**Note:** The ADAT optical connectors only support sample rates of 44.1kHz and 48kHz; they are not operational when the H9000 is set to run at higher sample rates of 88.2kHz or 96kHz.

## Operating the H9000

In this next section, we will show you how to navigate around the H9000 front panel, perform common operations, and operate the unit in general.

This section is divided into the following areas:

- Sessions
- FX Chains
- Algorithms
- Parameters
- Meters

### A Note on “Latching” Soft Keys:

The H9000 UI has context-sensitive “soft keys” on the left and right sides of the display.

There are two different types of soft keys on the H9000:

- “Normal” soft keys: These execute their labeled action when pressed
- “Latching” soft keys: When pressed, they change the front panel display to a different state. Think of the latching soft keys as a quick and easy way to access “sub-menus” or alternate screens on the H9000

Latching soft keys are visually distinguished by a small triangular “flag” in the top corner of the key.

In this user’s manual, any time you are presented with a list of soft key functions, latching soft keys will be distinguished with an underline.

## Things to Know About Signal Routing

There are a few general “rules” about signal routing in the H9000 which are useful to keep in mind.

- You can only use one of the following digital audio protocols at any given time:
  - AES3 (aka AES/EBU) over the DB25 connector
  - AES3 (aka AES/EBU) over the XLR connector
  - S/PDIF over the optical connector
  - S/PDIF over the RCA connector
  - ADAT over the optical connector
- When using S/PDIF over the optical ADAT connectors, you can only work at sample rates of 44.1kHz and 48kHz. 88.2kHz and 96kHz are not supported.
- FX Chains support 8 inputs and 8 outputs. However, the eight outputs of an FX Chain can be “multed” to an arbitrary number of physical Input/Output channels, computer audio interface channels, etc.

## Sessions

SESSION <b>001</b> ANALOG - STEREO IO			
NEW	■ 001 ANALOG - STEREO IO	1 Jan 2007 12:01am	SEARCH
	■ 003 ANALOG - 8 CHANNEL IO	1 Jan 2007 12:01am	
COPY	■ 004 ANALOG - 4 STEREO FX CHAINS	1 Jan 2007 12:01am	
DELETE	■ 005 USB - STEREO IO	1 Jan 2007 12:01am	PREVIEW
	■ 006 USB - 2 x 8 CHANNEL IO	1 Jan 2007 12:01am	
RENAME	■ 007 USB - 4 STEREO FX CHAINS	1 Jan 2007 12:01am	✓ LOAD

A *Session* is the “big picture” for the H9000, a snapshot of the current state of all settings on the unit.

To load a session, press the front panel *Sessions* button; the button will illuminate as a reminder you are currently working with the sessions screen.

The screen will switch to the Sessions view, presenting you with a numbered list of sessions available for loading. The presently loaded session is displayed in the title bar at the top of the screen.

There are several different ways to navigate through the list of sessions:

- Press the cursor up/down buttons or rotate the wheel to scroll through the list one entry at a time;
- Press the cursor left/right buttons to navigate through the Sessions list one page at a time.
- The session you have currently navigated will highlight in green.
- Press the *Enter* button to load the highlighted session.
- The chosen session will load and you will automatically be taken to the FX CHAINS screen where you can edit the session’s FX Chains.

## Session Screen Soft Keys

The 8 Session soft keys offer additional session-related functions:

- New
- Copy
- Delete
- Rename
- Search
- Preview
- Load

### **New**

Press the *New* soft key to create a new session.

If you have made changes to the currently loaded session, you will be prompted to save your changes; press the *Yes* or *No* soft key.

You will then see the *Create New Session* screen; press the *Create New Session* soft key (or the *Cancel* soft key if you wish to cancel out of the operation).

The new session you have created will be titled “Default Session” and will contain a single default FX Chain.

### **Copy**

Press the *Copy* soft key to make a copy of the currently highlighted session.

The naming screen will appear, allowing you to create a new name for the copy of the session. In this sense, it is similar to the “Save As” function on a word processor application, where you can save a copy of a currently loaded document under a different name.

### **Delete**

Press the *Delete* soft key to delete the currently highlighted session in the list. You will be prompted with a confirmation screen; press either the *Cancel* or *OK* soft keys.

Note that you cannot delete sessions that are part of the “Factory Sessions” group of presets. These sessions are meant to always be available on the H9000 and never be removed.

### **Rename**

Press the *Rename* soft key to rename a currently highlighted session. You will then be presented with the naming screen where you can enter in a new name for your session.

Note that you cannot rename sessions that are part of the “Factory Sessions” group of Session presets. If you attempt to do so, you will be presented with the option of creating a new user session, which you can then rename.

### **Load**

Press the *Load* soft key to load the currently highlighted session. This soft key duplicates the function of pressing the *Enter* key when a session is highlighted.

### **Search**

Press the latching *Search* soft key to bring up the search screen, where you can use the keypad to type in a keyword. Sessions containing the letters you type will appear in the filtered list of available sessions.

As you type additional characters, the list of sessions will further refine your search.

### **Preview**

Press the latching *Preview* soft key to get a visual representation of the layout of the session, such as:

- The number of FX chains
- The Algorithms in each FX Chain
- Physical Inputs and Outputs

Since loading a session is not an immediate operation, the *Preview* function offers a quicker way to see what the session contains before you actually load it.

## FX Chains

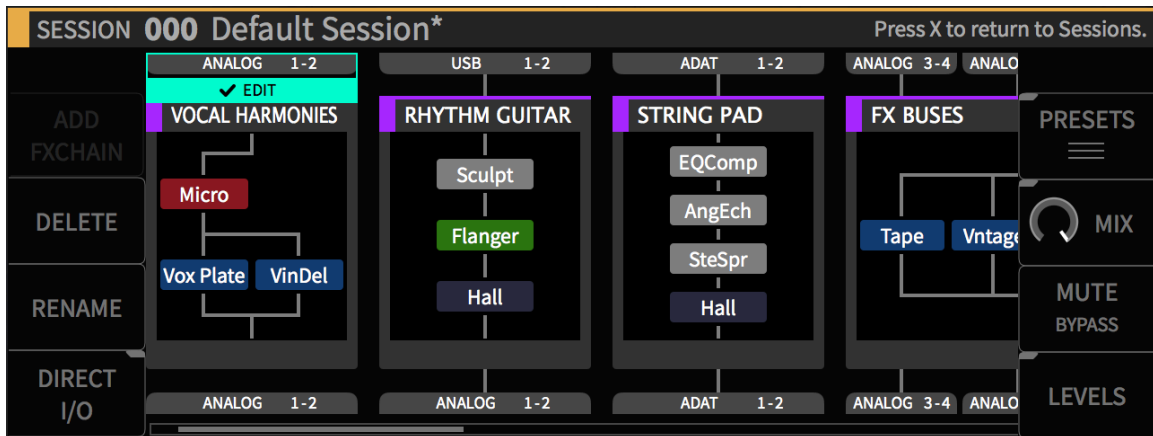

Press the front panel *FX Chain* button to switch the display to the *FX Chains* screen, where you can view and edit the various FX Chains of the currently loaded session.

Press the cursor left/right buttons or use the wheel to highlight the different FX Chains in the currently loaded session;

Press the cursor up/down buttons to move through the signal chain blocks in the currently highlighted FX Chains Block: An FX Chain is comprised of:

- Audio inputs
- The algorithms contained in the FX Chain
- Audio outputs

### Configuring the Audio Input/Output of your FX Chain

Use the cursor buttons to highlight the *Edit* block of the FX Chain's audio input section; you will then be presented with choices for selecting both the physical input connector, and then separately the channel number of your selected input connector.

Use the wheel to scroll through the available choices. When you have found your desired audio input, highlight the *Connect* block and press the Enter key.

Your chosen input source will now be routed to the input of the FX Chain and the display will show a connecting line to show that the connection has been made.

To assign an output to the FX Chain, follow the same procedure using the *Edit* block located at the bottom of the FX Chain display.

**Note:** You cannot select an Output that has been previously assigned to another FX Chain.

## Replacing the Algorithm Used in an FX Chain

The middle section of the FX Chain block shows the Algorithm(s) that make up the current FX Chain. To replace the current FX Chain with a different FX Chain preset:

- Highlight the latching *Replace* soft key to initiate the replacement process. You will be presented with a list of available FX Chain presets.
- Navigate to the FX Chain preset you wish to use as a replacement then press the *Replace* soft key.
- Press the *Enter* key to insert the chosen preset into the FX Chain as a replacement for the previous one.

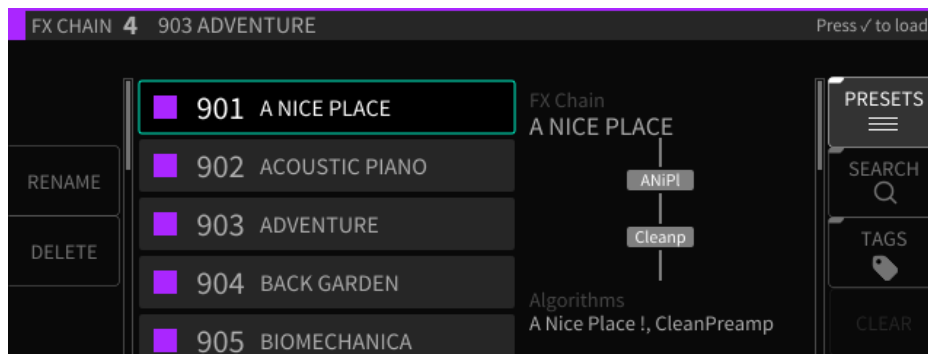

At any time, you can press the *Exit* button to back out of the current screen state and return to the previous state. Pressing the *Exit* button a final time will exit the FX Chains screen and return you to the *Sessions* screen.

**Note:** You can always return to the *Sessions* screen by pressing the *Exit* button once for each iteration of menus you have entered. In other words, if you're in too deep and need to reset, press the *Exit* button a couple of times to go back home.

## FX Chain Soft Keys

The FX Chain screen contains 8 soft keys that offer the following functions:

- Add
- Delete
- Rename
- Direct I/O
- Mix
- Mute/Bypass
- Levels



**Add:** Press the *Add* soft key to add a new FX Chain to the currently loaded session.

You can have up to four FX Chains in your H9000. The H9000 will prompt you to select an I/O configuration for the FX Chain, which will be routed automatically upon creation.

**Delete:** Press the *Delete* soft key to delete the currently highlighted FX Chain. Note that you cannot delete the FX Chain if it is currently the only one loaded in the session.

**Rename:** Press the *Rename* soft key to bring up the naming screen, where you can rename the currently highlighted FX Chain container in the session.

Note that the name of the FX Chain *container* is distinct from the name of the FX Chain preset *loaded into it*; this can be useful for distinguishing an FX Chain's purpose (e.g. Guitar 1, Guitar 2) if the same preset is loaded into multiple containers.

### **Mute/Bypass**

Press the *Mute/Bypass* soft key to mute the currently highlighted FX Chain. Press it again to unmute the FX Chain.

When muted, a red "Mute" label will appear at the bottom of the FX Chain block.

Long-press the *Mute/Bypass* soft key to bypass the currently highlighted FX Chain. Long-press it again to un-bypass the FX Chain.

When bypassed, a red "Bypass" label will appear at the bottom of the FX Chain block.

## Direct I/O

Press the latching *Direct I/O* soft key to create a “Direct I/O” Signal Chain. This is not an FX Chain, but rather a direct audio pathway between a physical audio input and audio output.

Direct I/O allows you to take advantage of your H9000 as a network attached I/O box, making the H9000’s pristine analog converters available for highest quality analog I/O.

Even at times when you do not require any of the external processing the H9000 can provide, the 8 analog input and outputs, along with their different routing options, allows the H9000 to work as a network-attached patch bay.

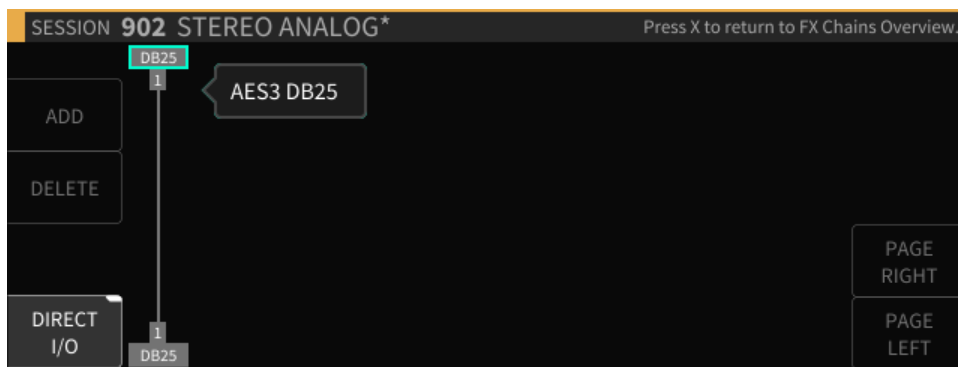

In the Direct I/O screen, use the cursor keys to highlight the input/output you wish to assign, then use the wheel to select the physical input /output you wish to use in your direct I/O pathway.

Four additional soft keys are available in the Direct I/O screen:

- *Add*: Press the *Add* soft key to add another direct I/O pathway within the Direct I/O screen.
- *Delete*: Press the *Delete* soft key to delete a Direct I/O pathway that you have highlighted.
- *Page Left/Right*: Press the *Page Left/Right* soft keys to navigate among the different direct I/O pathways you have created, when there are more of them than fit on the screen at one time.

**Note:** Direct I/O assignments are saved with Sessions, not with FX Chains.

## The FX Chain Preset Browser

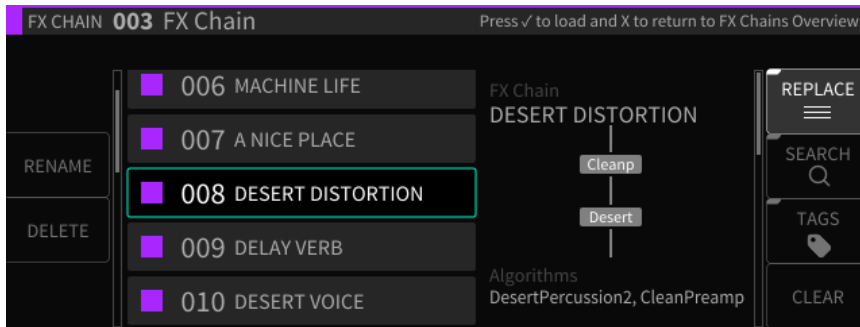

- Press the *Presets* soft key to enter the FX Chain preset browser.
- Navigate to the FX Chain you wish to load and press *Enter* (✓).

### Rename

Press the *Rename* soft key to rename the currently highlighted FX Chain. Note that factory FX Chains cannot be renamed.

### Delete

Press the *Delete* soft key to delete the currently highlighted FX Chain preset. Note that factory FX Chains cannot be deleted.

### Search

Press the latching *Search* soft key to bring up the virtual keypad, where you can enter in letters and numbers to search for a specific FX Chain or algorithm name. As you enter in more characters, the algorithm list is filtered to show only FX Chains that contain the characters you are typing.

### Tags

Press the latching *Tags* soft key to switch the right-hand side of the display to the Tags screen. You will be presented with a list of tag categories, which you can use the cursor keys and enter key to select.

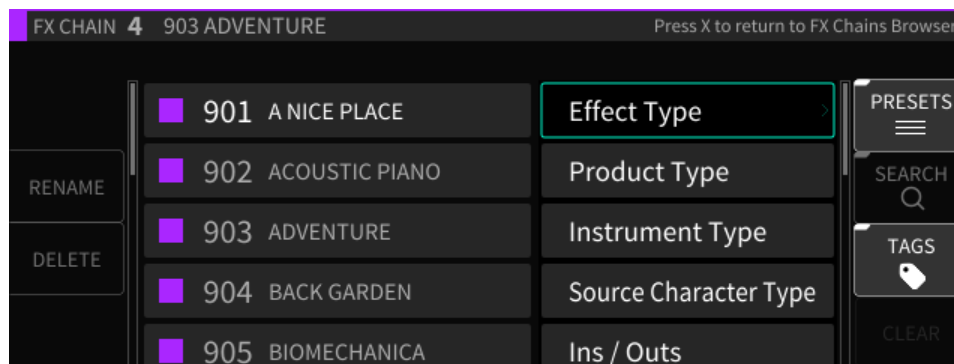

The following tag categories are included:

- Effect Type
- Product Type
- Instrument Type
- Source Character Type
- Inputs/Outputs

Once you have selected a specific tag category, you will be presented with a menu of specific tags within that category. Use the cursor and enter keys to select a specific tag; it will be added to the current tag list and be shown above the tag list.

Note that you can select as many tags at once as you like. As you add tags, the master list of FX Chains will be filtered to only show presets that correspond to the tag(s) you have selected.

Also note that many of the algorithms on the H9000 will carry multiple tags – for example, Blackhole will fall under the tags of Product Type → H9 as well as Effect Type → Reverb. In this way, you can reach the same algorithm in a number of different ways.

This powerful feature is a great way to narrow down the H9000's vast list of FX Chain presets to a more manageable selection that is appropriate to the task at hand.

### **Clear**

Press the *Clear* soft key to clear all currently loaded tags, and return the master list of FX Chains to its complete state.

### **Mix**

Press the latching *Mix* soft key to adjust the mix levels of the FX Chains present in the currently loaded session.

The display will switch to the *Mix* screen, showing level controls for each FX Chain. Use the cursor keys to navigate to the FX Chain for which you wish to adjust the level, then use the wheel to adjust its mix level.

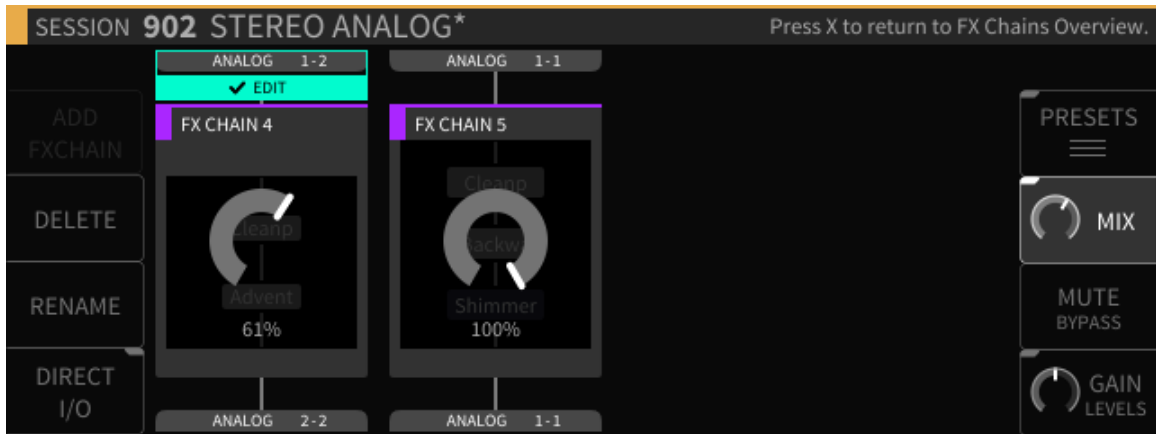

### Levels

Short press the latching *Gain/Levels* soft key to adjust the output gain levels of the FX Chains present in the currently loaded session.

Similar to the *Mix* mode, the display will show level controls for each FX Chain. Use the cursor keys to navigate to the FX Chain for which you wish to adjust the level, and use the wheel to adjust its output gain.

Long-press the latching *Gain/Levels* soft key to show signal levels for the audio inputs/outputs of the currently highlighted FX Chain. The levels screen contains its own set of soft keys, as follows:

### Clear Clip

Press the *Clear Clip* soft key to clear any overloads that are displayed on the I/O meters.

### Group

Press the latching *Group* soft key to group together the inputs or outputs of the selected FX Chain input or output level.

When the latching soft key is illuminated, adjusting the level of either fader will adjust the level of both equally.

## Algorithms

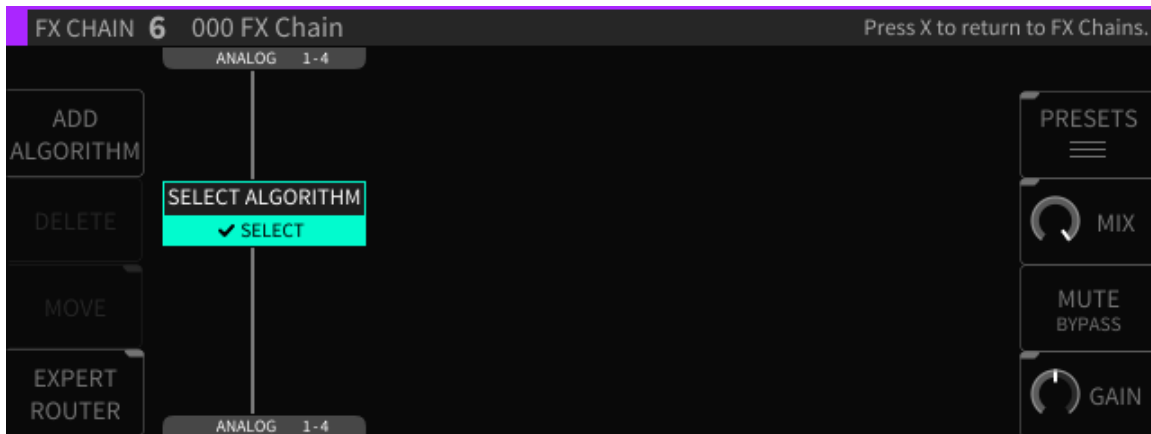

In the H9000, each FX Chain can contain up to four separate signal-processing Algorithms. The *Algorithms* screen is where you work with these specific algorithms; you can navigate to it by either:

- Pressing the *Algorithms* button on the front panel, or;
- Highlighting the *Edit* button in the center portion of an FX Chain block, then pressing the *Enter* button.

The screen will switch to the Algorithms display and the front panel Algorithms button will illuminate.

### Algorithms Overview

The Algorithms overview screen displays the specific algorithms that make up the currently highlighted FX Chain.

The display shows the different algorithms present, their routing within the FX Chain, and the audio inputs/outputs that feed the FX Chain.

Rotate the wheel to navigate to the different objects in the FX Chain, which include:

- Algorithm processing blocks
- Input and Output blocks

When viewing the Algorithms overview screen, pressing the *Enter* button works contextually for whatever specific object you have highlighted:

- *Algorithm*: When the *Edit* label is highlighted, pressing *Enter* takes you to the Parameters page (see *Parameters* section for more details)

- *I/O Label*: Pressing *Enter* takes you to the editor screen for the audio inputs/outputs

### **Configuring Audio I/O For an Algorithm**

To configure the audio I/O on the Algorithms Overview screen:

- Use the cursor keys to highlight the audio input or output block you wish to configure.

Note that you can then use the cursor keys to highlight *only* the audio I/O category (Analog, Digital, Card Slot), then cursor over to the channel number and adjust it separately.

This type of fine-tuned I/O control is particularly important when an option card slot is populated with a networked audio option card, which can have dozens of I/O channels per slot.

- Use the wheel to cycle through the available input or output assignments.
- Press the *Edit* soft key to allow for finer control configuring audio I/O for the selected algorithm.

### **Algorithm Screen Soft Keys**

The algorithms Overview screen contains eight Soft Keys:

- Add Algorithm
- Delete
- Move
- Expert Router
- Presets
- Mix
- Mute/Bypass
- Gain

## Add Algorithm:

- Press the *Add Algorithm* soft key to add a new algorithm to the currently selected FX Chain. A new algorithm block will appear labeled “Select Algorithm”.
- Use the cursor keys to highlight the “Select Algorithm” block and press the *Enter* (✓) key.

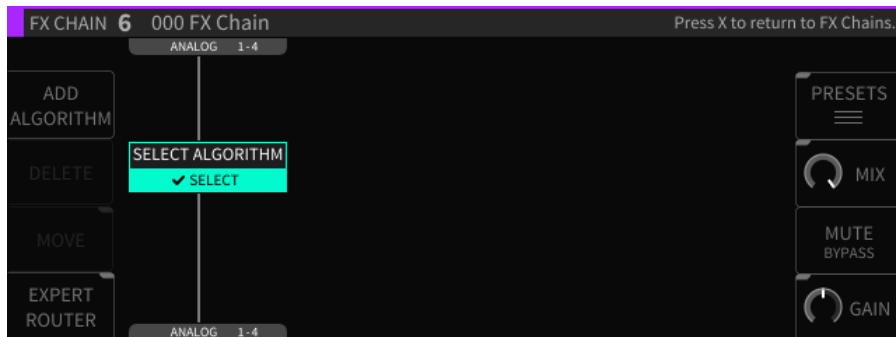

- Use the navigation controls to select an Algorithm. Each entry contains helpful info (number of inputs and outputs, a description of the algorithm, tips on its use, etc.).

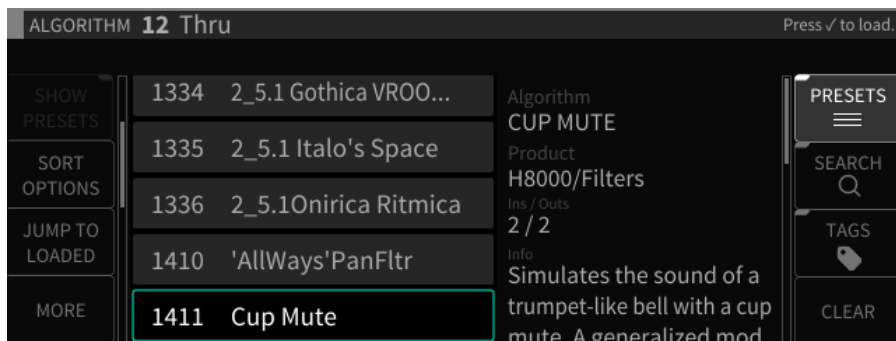

## Delete

Press the *Delete* soft key to remove the highlighted algorithm from the FX Chain.

## Move

Press the *Move* soft key to change the location of the algorithm within the FX Chain. You can move an algorithm in an FX Chain to be above or below any other algorithm in series, or next to another algorithm in parallel.



## Mix

Press the latching *Mix* soft key to change the display to a set of mixing controls, where you can control the relative level of each Algorithm within the FX Chain.

Use the cursor keys to navigate to the Algorithm you wish to adjust the mix level for, then rotate the wheel to adjust its mix level.

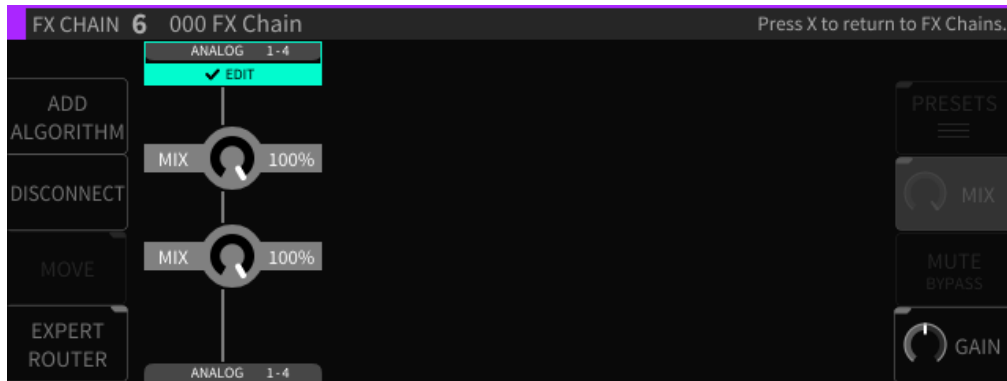

## Gain

Press the latching *Gain* soft key to change the display to a set of gain controls, where you can control the output level of each Algorithm within the FX Chain.

**Note:** The difference between the Gain control and Mix control is that Gain determines the overall signal presence of an algorithm in an FX Chain, whereas Mix controls the overall Wet/Dry mix of an individual algorithm and its signal.

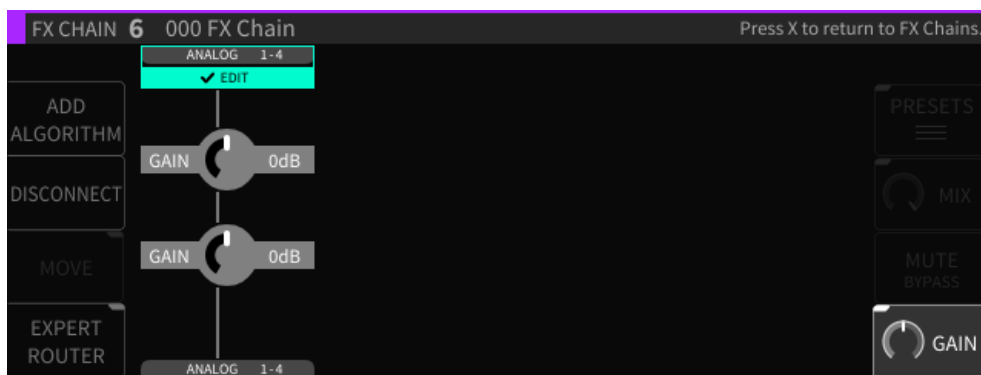

## Mute/Bypass

Press the Mute/Bypass soft key to mute the audio output of the currently highlighted Algorithm. A red "Mute" label will appear at the bottom of the Algorithm block when muted.

Press the Mute/Bypass soft key again to unmute the audio output.

Long-press the Mute/Bypass soft key to bypass the currently highlighted Algorithm. A red “Bypass” label will appear at the bottom of the Algorithm block when muted.

Long-press the Mute/Bypass soft key again to un-bypass the audio output.

## Expert Router

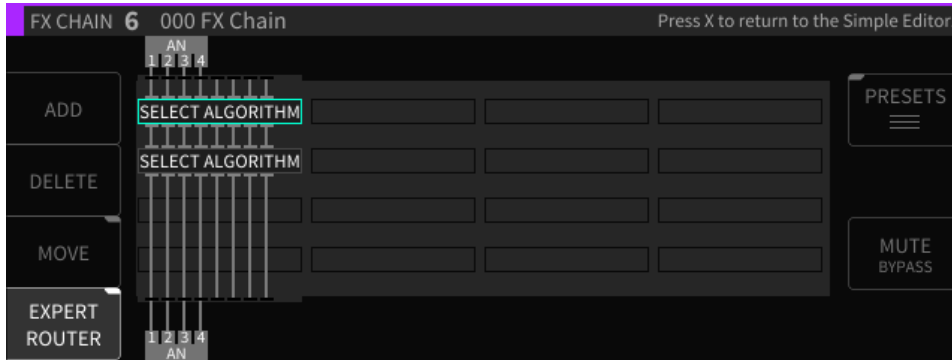

Press the latching *Expert Router* soft key to enter the “Expert Routing” mode. The display switches to a graphical routing matrix, where you can view and edit a high-level detailed overview of:

- All of the algorithms present in the current FX Chains.
- Their audio I/O assignments.
- Their signal routing configuration.

**Note:** The H9000 allows not only serial routing of algorithms, but also parallel and mixed serial/parallel routing as well. The expert page is where you can view and control this aspect of the routing.

To make adjustments in the *Expert* screen:

- Use the cursor keys to highlight the aspect of the block diagram you wish to adjust (audio I/O block, routing, Algorithm).
- Use the wheel to adjust a highlighted audio I/O routing.
- Use the *Move* soft key to adjust a routing pathway when it is highlighted

## Algorithm Selection Screen



The Algorithm Selection Screen shows a list of the different algorithms available on the H9000. To the right of the list is a description that shows information for the currently highlighted algorithm, including:

- Algorithm Name
- The specific Eventide product the Algorithm is sourced from
- Numbers of Inputs and Outputs available in the Algorithm
- A description of the algorithm and tips on its use

Note that the description field will usually contain more text than can fit on the display; in this case, use the cursor keys to highlight the description field, then rotate the wheel to view the remaining description text.

For a quick overview of the thousands of H9000 algorithms, refer to the Appendix *H9000 Algorithms* located at the end of this document.

### Algorithm Presets

Some Algorithms also contains *Presets*, which are variations of each Algorithm with their parameters configured for different sounds. For a quick overview, refer to the Appendix *H9000 Presets* located at the end of this document.

Press the latching *Presets* soft key to shows/hide the Presets contained within each Algorithm. This approach makes it easier to navigate all of the H9000's unique Algorithms, without having to wade through all of the presets contained within some of the Algorithms.

The Algorithm Presets screen contains numerous following soft keys, as detailed below:

### **Sort Options**

Press the Sort Options soft key to select which way the Algorithm presets are sorted, including:

- By ID Ascending
- By ID Descending
- By Name
- By Recently Used
- By Most Used

Use the cursor up/down keys to navigate to the sort option you wish to use, and then press the *Enter* key.

### **Jump to Loaded**

Press this soft key to jump to the algorithm that is currently loaded in the FX Chain.

### **Search**

Press the latching *Search* soft key to bring up the virtual keypad, where you can enter in letters and numbers to search for a specific Algorithm name. As you enter in more characters, the list is filtered to show only algorithms that contain the characters you have typed.

### **Tags**

Press the latching *Tags* soft key to switch the right-hand side of the display to the Tags screen. You will be presented with a list of Tag categories, which you can use the cursor keys and enter key to select.

Tag categories are:

- Effect Type
- Product Type
- Instrument Type
- Source Character Type
- Ins/Outs

Once you have selected a specific tag category, you will be presented with a menu of tags within that category.

Use the cursor keys and *Enter* key to select a specific tag; it will then be added to the current tag list and be shown above the tag list. Note that you can select as many tags at once as you like.

As you add tags, the master list of algorithms will be filtered to only show presets that contain text matching the tag(s) you have selected. This powerful feature is a great way to narrow down the H9000's vast list of presets to a more manageable selection, one that is appropriate for the task at hand.

### **Clear**

Press the *Clear* soft key to clear all currently loaded tags and return the master list of Algorithms to its complete state.

### **More**

Press the *More* soft key repeatedly to switch the soft keys above it to alternate functions. These additional soft keys include:

### **Jump to Last**

Press this soft key to jump to the algorithm most recently viewed in the list.

### **Jump to Loaded**

Press this soft key to jump to the algorithm that is currently loaded in the FX Chain.

### **Bank Up/Bank Down**

Press these two soft keys to quickly jump to the next/previous bank of algorithms.

### **Rename**

Press the *Rename* soft key to rename the currently highlighted Algorithm. Note that factory Algorithms are saved permanently in internal memory and cannot be renamed.

### **Delete**

Press the *Delete* soft key to delete the currently highlighted Algorithm. Note that factory Algorithms are saved permanently in internal memory and cannot be deleted.

**Note:** As seen in the list of Algorithms located in the appendix, the H9000 algorithms are organized into different banks, each one representing different categories of effects. Each bank begins with a new 3-digit number (100, 200, etc.).

### **Replace**

Highlight an algorithm in the list, then press the latching *Replace* soft key. The screen will switch to the currently highlighted FX Chain, and you will be presented with the option of replacing its currently loaded Algorithm with the one you had just highlighted.

Press the latching *Replace* soft key again at any time to exit the replacement process.

**Note:** Certain algorithms will not work when the H9000 is running at a sample rate of 88.2kHz or 96kHz. These algorithms will appear with a red “stop sign” icon in the Algorithm list, and will not load if selected.

If you switch to a higher sample rate with one of these algorithms already loaded, the user interface will indicate which algorithms are invalid, allowing you to delete or replace them. For already loaded algorithms, they will appear in the Algorithms mode view with a red strike-through over the container.

## Parameters

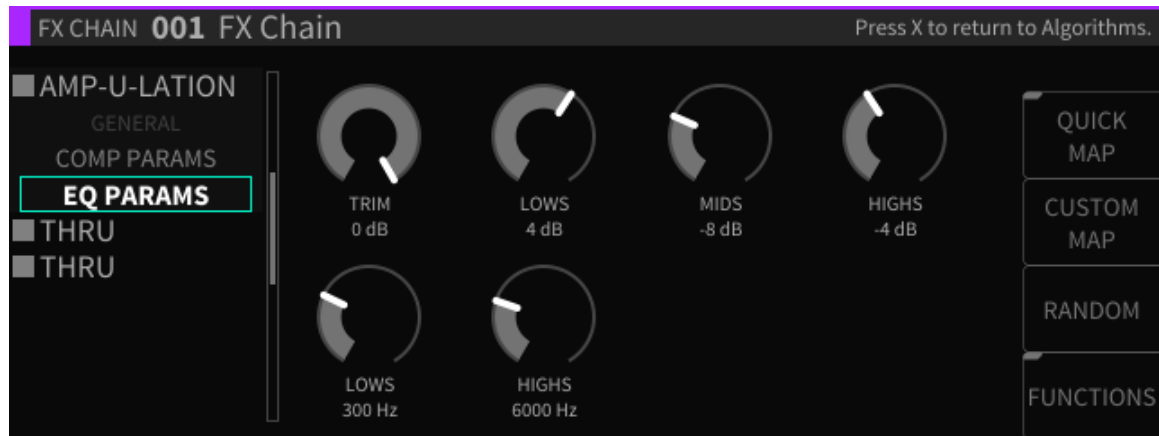

On the H9000, each Algorithm contains a set of parameters; you adjust these parameters to adjust the sound of the Algorithm you have selected.

For example, a reverb Algorithm contains parameters for settings such as room size, decay time, pre-delay, and so on. The *Parameters* screen allows you to view and adjust these parameters.

To switch to the *Parameters* screen:

- When the *Edit* label is highlighted, press the *Enter* key when an algorithm is highlighted; you will be taken to the Parameters screen for that algorithm.
- Alternatively, press the front panel *Parameters* button.

The parameter page offers a handy list on the left-hand side of the screen, which displays:

- The master parameters for the current FX Chain container
- The algorithms currently loaded in the selected FX Chain
- The parameter categories within each algorithm

Use the cursor keys to highlight the specific parameter category you wish to view the parameters for. The screen will then display the parameters for only that category.

This approach allows you to more easily “get your head around” the large number of parameters that may be available to you. Many algorithms contain a large number of parameters, and a single list of all of them would not be very intuitive to work with.

## Editing Parameters in an Algorithm

To adjust a specific parameter:

- Use the cursor up/down keys to navigate to a specific parameter category; the right-hand side of the screen will display the specific parameters within that category.
- Use the cursor left/right keys to highlight the specific parameter you wish to adjust.
- Use the *Enter* key and/or wheel to adjust the parameter you have highlighted.

**Note:** You can also use the two middle-left soft keys to page up/down among the parameter categories, or the two outer-left soft keys to page up / page down through the Algorithms, while highlighting parameters within the parameter view.

This can be a faster way to work than using the cursor keys exclusively; you can jump around the screen quickly and don't need to constantly "cursor left" back to the parameter category list.

The parameters screen contains four additional soft keys:

- Quick Map
- Custom Map
- Random
- Functions



## Quick Map

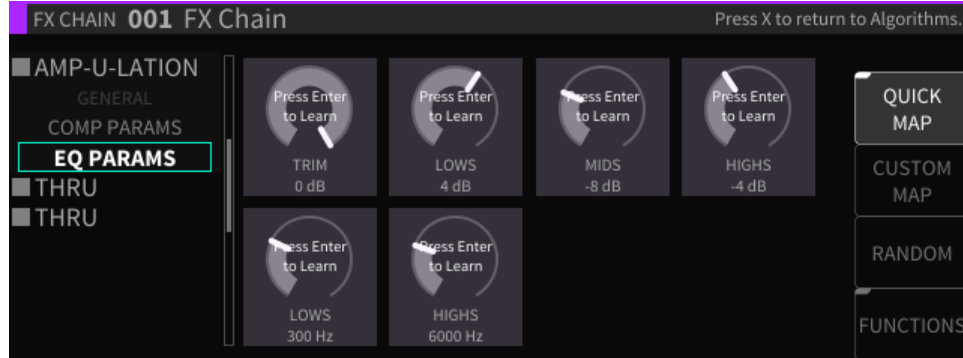

Press the latching *Quick Map* soft key to bring up the quick mapping function for the parameters you are viewing.

The quick map feature is extremely powerful, as it lets you quickly map a wide variety of MIDI controller software or hardware to any Algorithm parameter on the H9000. Different aspects of different processing effects can be adjusted in real time using hardware faders, knobs, foot pedals, buttons, etc.

The MIDI functionality on the H9000 is “plug-and-play”. You can connect a MIDI device to the 5-pin DIN ports, or connect a MIDI class compliant interface to one of the USB connectors. All MIDI Channel configuration is done when individual controllers are mapped, as opposed to in a central MIDI settings screen.

You can even map multiple parameters to a single MIDI continuous controller; you cannot, however, have multiple MIDI controllers affect a single parameter.

For more complex mapping of multiple parameters to a single control source, please refer to the FUNCTIONS section.

The *Quick Map* feature works as follows:

- Press the *Quick Map* soft key; you will see a “Press Enter to Learn” label superimposed over each of the parameters on the screen.
- Use the cursor buttons to navigate to the parameter you wish to map a controller to.
- Press the *Enter* button; the highlighted parameter’s label will change to “Move Any Controller”.
- Move the MIDI hardware/software control you wish to pair to the highlighted parameter.

- The MIDI hardware/software controller and the parameter are now paired.

### Custom Map

The *Custom Map* feature is also designed to map MIDI controllers to H9000 parameters, but with a much finer level of control. It works as follows:

- Use the cursor keys to navigate to the parameter you wish to custom map a controller to, then press the *Enter* key.
- The “Controller Type” popup menu will appear, where you can select from the following types of MIDI hardware controllers you wish to map:
  - Expression Pedal 1-4
  - Switch 1-6
  - Note On
  - Poly Pressure
  - MIDI CC (Continuous Controller) Single
  - MIDI CC (Continuous Controller) Double
  - MIDI Program Change
  - Channel Pressure
  - Pitch Wheel
  - MIDI Start
  - MIDI Stop
- Navigate to the controller type you wish to use then press the *Enter* key; many of the controller types listed above will contain additional settings that you can select.
- Press the *Enter* key to navigate to the controller type you wish to use; you will then be presented with an additional set of controls that allow you to refine the mapping:
  - Control Minimum
  - Control Maximum
  - Value Minimum
  - Value Maximum

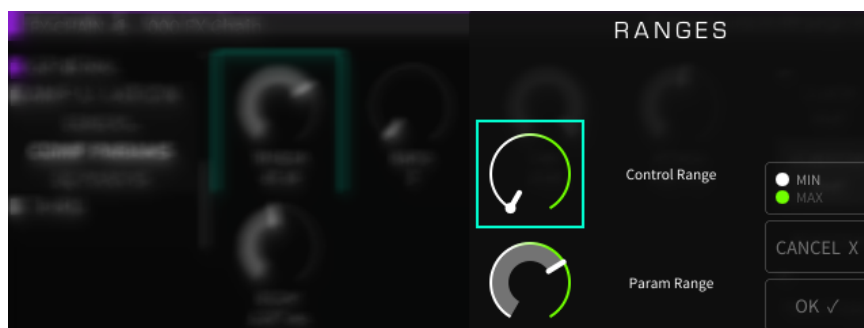

- Use the cursor keys to navigate among the above 4 controls, then use the wheel to set their value.
- When you have finished, press the *OK* soft key and the custom mapping will be completed.
- The display will return to the *Parameters* display. You will now see a green text label above the parameter, showing you the specific controller you have mapped to that parameter.

### **Random**

Press the *Random* soft key to instantly assign random values to each and every parameter of the Algorithm you are currently working with.

This extremely creative function allows you to try out different Algorithms in a free-form “what-if” type scenario, because the different parameter values are all selected with no specific purpose or sound in mind. Give it a whirl with your favorite algorithm and see what happens...

## Functions

*Functions* in the H9000 act much like Macros in Ableton Live; essentially, they are higher-level groupings of parameters that can be adjusted with a single knob.

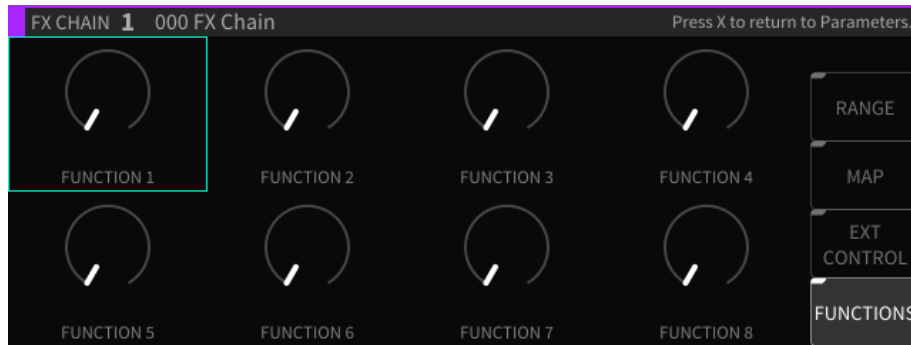

There are 8 Functions available in each FX chain, with the following three parameters available:

- Range
- Map
- Ext Control

## Range

Each parameter that belongs to a Function has a defined range; it can be as large as the true Minimum/Maximum range of the Parameter, or anywhere in-between. It can also be inverted, becoming Max/Min). The main Function knobs then cause each parameter change to be scaled, according to its defined range.

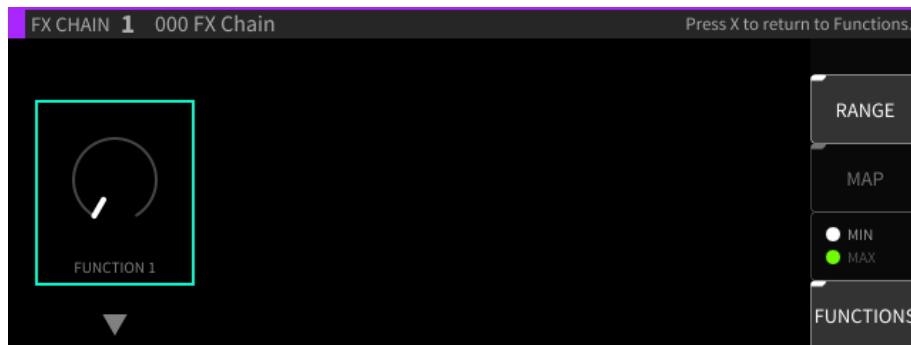

## Minimum/Maximum

You can use the Min/Max soft key to toggle between adjusting the minimum or maximum value of the range, as indicated by the white and green end cap markers.

## MAP

The *Map* view displays a condensed view of all the parameters in the FX chain, allowing selection of them for assigning to Functions. The Add/Remove key assigns/unassigns the parameter, depending on which Function is selected.

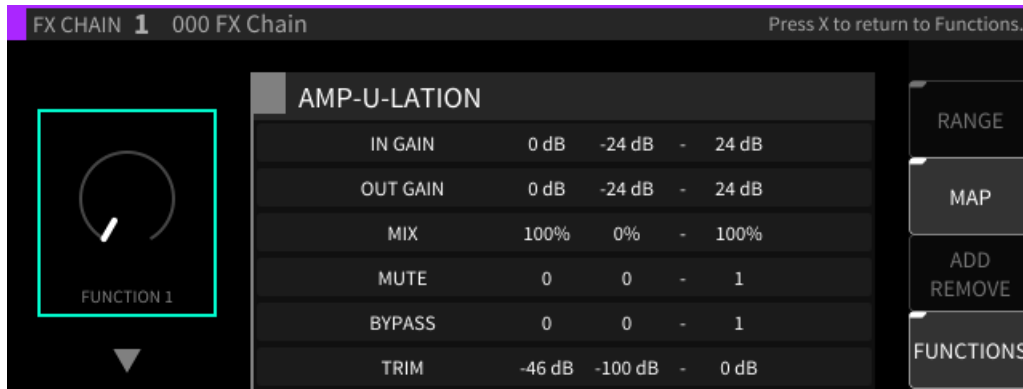

- Highlight the Function knob on the left side of the display.
- Use the cursor up/down keys to select which of the 8 functions to work with.
- A list of available parameters will appear; use the cursor up/down keys to highlight the function you wish to map.
- Press the *Enter* key; the highlighted parameter is now mapped to the Function knob you had selected, and that Function's number (e.g. F1) now appears on the left side of that parameter's entry in the list.

If a function is already mapped to a parameter you have highlighted, pressing the *Add/Remove* soft key will remove the mapping.

## External Control

External Control offers the same interface for mapping MIDI/foot controllers as individual parameters, but for the higher-level Function controls.

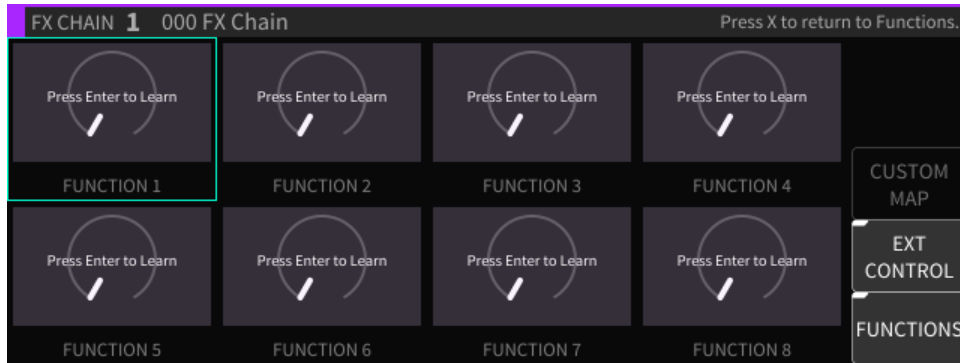

- Use the cursor keys to highlight one of the 8 functions.
- Press the *Enter* key to learn a command.
- Move the control on your external MIDI Controller; that control will now be mapped to the highlighted function.

The Custom Map dialog can also be accessed through this interface, and utilized in the same way as for normal Parameters.

## Meters

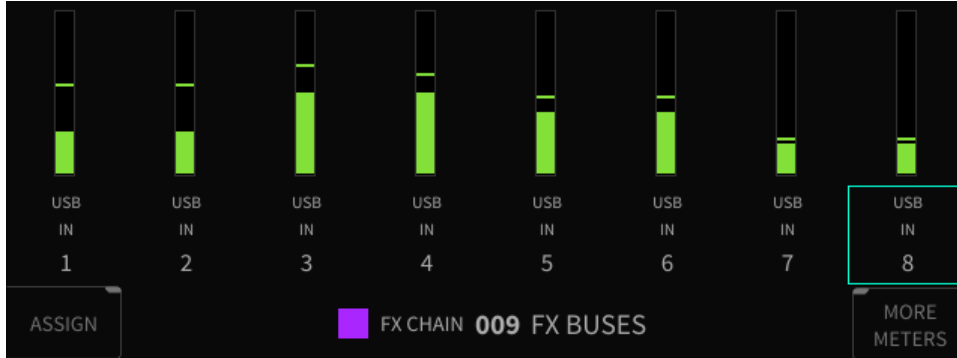

The H9000 offers a set of 8 dedicated 3-segment hardware LED meters, positioned above the front panel color display. These LED meters are always active.

The first segment of the hardware LED meter represents signal presence, at any dB level. The second segment, if lit, means the signal is reaching -6dB – in other words, nominal headroom and nominal S/N ratio. The third segment represents a signal overload, or too much signal presence.

For a more detailed metering view, press the front panel *Meters* button to switch the color display to the Meters page.

The *Meters* page displays 8 channels of metering at a time, and allows you to assign which signal sources are assigned to the metering display.

### Assigning Input/Output sources to Meters

- On the main metering page, use the cursor buttons or the wheel to navigate to the metering slot you wish to assign an audio input or output to.
- Press the *Enter* key, or the *Assign* soft key, to make an assignment.
- You will be presented with a list of all physical input channels; use the cursor up/down buttons or wheel to navigate to the physical input you wish to assign.

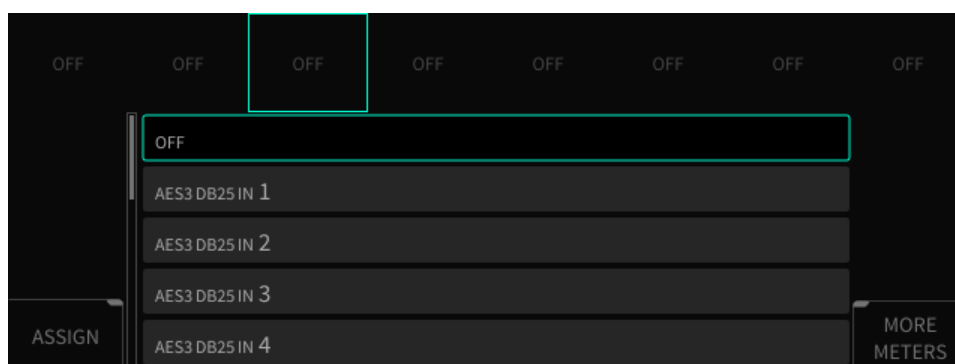

- Press the *Enter* button to select your choice; the selected input/output is now assigned to the highlighted metering channel, and that channel will now show the assignment above the channel number.

On a stock H9000 unit with no expansion cards installed, the following single input/output channels can be assigned to the meters:

- Off
- Digital Audio Connector In 1-8
- Analog In 1-8
- USB In 1-16
- FX Chain In 1-8 (for however many FX Chains are currently running)
- Digital Audio Mode Connector Out 1-8
- Analog Out 1-8
- USB Out 1-16
- FX Chain Out 1-8 (for however many FX Chains are currently running)

### More Meters



Press the latching *More Meters* soft key to enter the *More Meters* screen; the display changes to show metering data for the currently loaded available FX Chains.

The *More Meters* screen also has soft keys for the following functions:

- Clear Clips
- Levels
- I/O Meters

**Clear Clips:** Press this soft key to clear any overload clips that have occurred.



**Levels:** Press this latching soft key to switch to the *Levels* screen; you are presented with input and output level faders for the currently selected FX Chains.

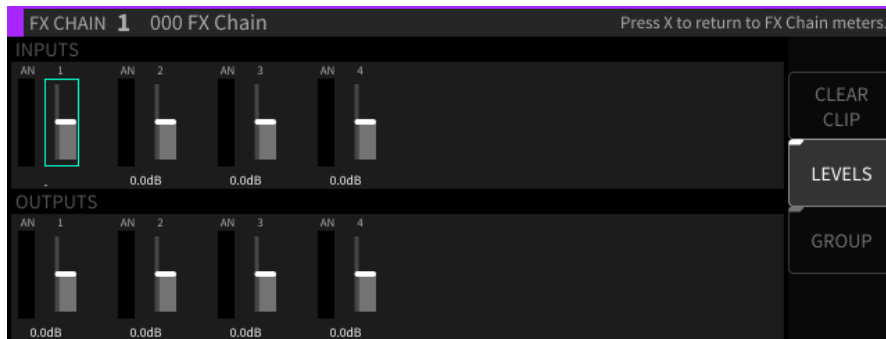

Use the cursor buttons to navigate to the input or output slider you wish to adjust, then use the wheel to adjust the signal level fader of the highlighted fader.

On the levels screen, press the latching *Group* soft key to group together level faders. When the latching soft key is illuminated, adjusting the level of either fader will adjust the level of both equally.

**I/O Meters:** Press the *I/O Meters* soft key to display the I/O meters screen; you will be presented with metering views for the H9000's banks of physical inputs and outputs, regardless of what custom assignments you have made in the main metering screen.

The I/O meters screen shows which bank of I/O metering you are on in the upper left corner, and which of the 8 pages you are on in the upper-right corner. On a stock H9000 with no expansion cards installed, the following 8 views are available:

1. Digital Audio Connector In 1-8
2. Analog In
3. USB In 1-8
4. USB In 9-16
5. Digital Audio Connector Out 1-8
6. Analog Out
7. USB Out 1-8
8. USB Out 9-16

Use the cursor up/down buttons or wheel to navigate among the 8 pages of metering views.

**Note:** While in the I/O Meters page, you can use the navigation keys to navigate around the meters, IF a Physical Input/Output is routed to or from an FX Chain. In this scenario, you can highlight the meter to see which FX Chain specifically. This is indicated by a purple square under the meter, and the corresponding label bar at the bottom of the page.

## Saving and Importing Data

The H9000 allows you to save various types of data, both to its internal memory as well as to an off-the-shelf USB drive connected to the front or rear panel USB ports.

Once you have saved this data to an attached drive, you can import it to a H9000, allowing you to easily share your work between different machines.

The importing/saving process works as follows:

**Note:** The USB drive must be formatted in *FAT32* format. The most recent versions of Windows and OS X do not offer FAT32 formatting as part of their built in disk utilities, so depending on the version of Windows or OS X your computer is running, you may need to format the drive with a 3<sup>rd</sup> party utility.

## Saving

Press the front panel *Save/Import* button. The *Save* screen will appear and you will be presented with the following options:

- Save Session
- Save FX Chain
- Save Preset
- Export Sessions
- Export Presets
- Export FX Chains
- Export Algorithms

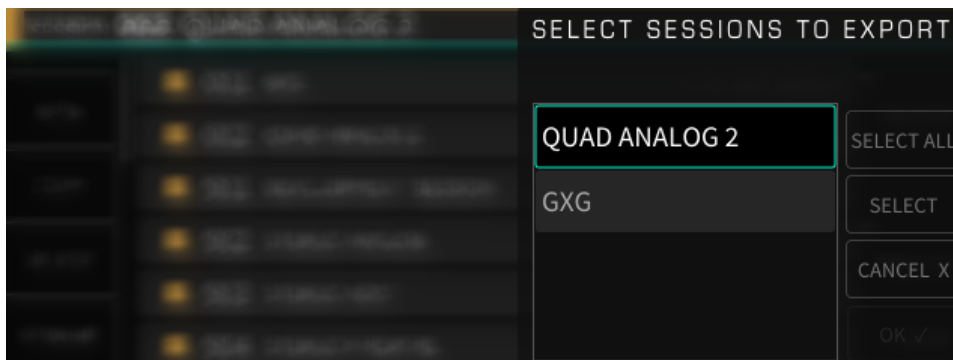
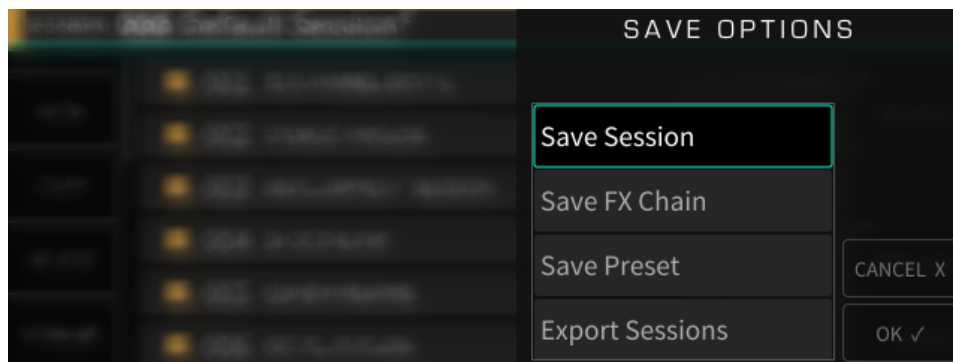

The data to be saved is contextually based on the currently selected item, as follows:

- *Save Session* will always save the currently loaded session.
- For *FX Chains and Presets*, the current FX Chain and Algorithm container selected on the screen will be the items saved for each save option.

At any time, you can refer to the cursor highlight or the title bar in the FX Chain or Algorithms mode view in order to see the currently selected item.

- Navigate to one of the choices above and press the *Enter* (✓) key to access the naming screen.
- Use the front panel keypad to type a custom name for your saved data, then press the *OK* soft key. The data will be saved to the H9000's internal storage.
- If a USB drive is attached, you will then be presented with the option to also save the data to the drive as well.
- Press the *YES* soft key to save your data to the attached USB drive; you will receive a confirmation message that the data was saved successfully.

### **Exporting Data**

If you have a USB stick plugged in, you will also see the "Export" options. The export options will NOT appear in the list if no drive is attached.

Whereas "Saving" refers to storing something onto the H9000's internal memory, "Exporting" transfers it from the box to the flash drive.

Note that when Saving with a USB stick plugged in, you'll be given the option to also Export after the save is complete.

## Importing Data

Once you have saved H9000 data to a USB drive, that data can be imported back into any H9000 unit by connecting the drive. Importing works as follows:

- Attach a USB drive containing H9000 data to a USB port of your H9000.
- Long-press the front-panel Save/Import button; the *Load Options* screen will appear.
- Use the cursor up/down buttons or wheel to navigate to the specific type of data you wish to load, then press the *Enter* key. Options include:
  - Sessions
  - Presets
  - FX Chains
  - Algorithms

**Note:** Any loaded Algorithms would be sourced from a 3<sup>rd</sup> party development environment, such as Eventide's "VSIG" software editor. The VSIG software is available for download at:

<https://www.eventideaudio.com/products/software/algorithm-editor/vsig>

Use the cursor up/down keys or wheel to select the data you wish to load, then press the SELECT key; the selected data will be loaded into memory.

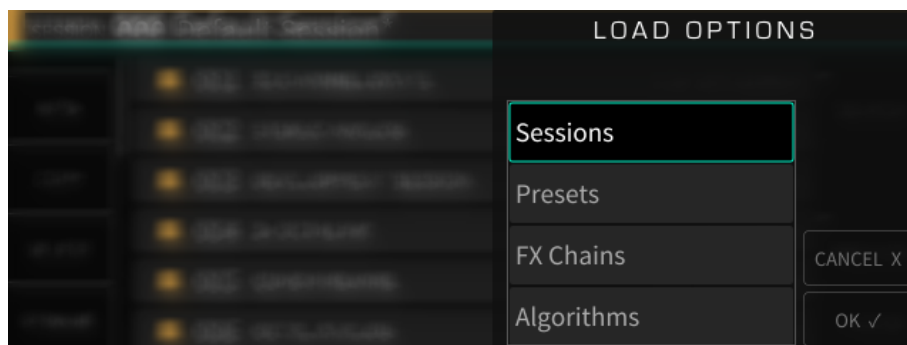

If you wish to load all of the data in the list, press the SELECT ALL soft key instead, or press the CANCEL soft key to cancel out of the load operation.

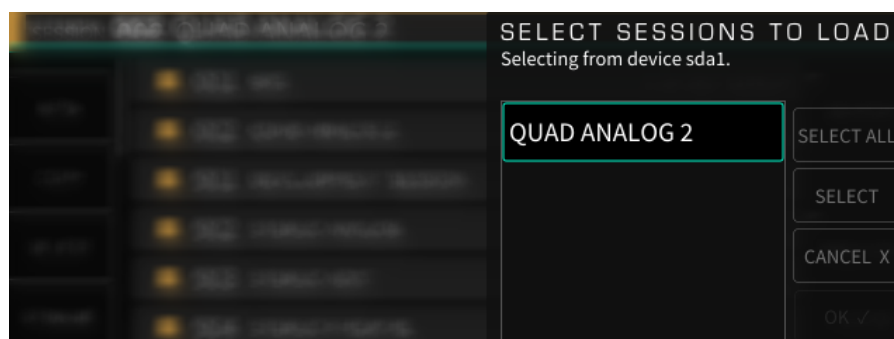

## Scenes

Long press the front panel *Tap/Scenes* button to bring up the SCENES screen. The H9000 can hold 128 scenes in its internal memory.

### Overview

Scenes are a high-level functionality used to control sequenced program changes in the H9000. This mode can be useful when you are using the H9000 in a live environment such as a concert or theatrical production, and wish to “step through” different pre-configured states in a certain order you have set up in advance.

For example, the main vocalist in a concert may need different reverb parameters at different times during the show; scenes provide a quick, simple way to achieve this.

- You can create multiple “Scene Maps” and select which one is active at any given time.
- A Scene Map is a collection of Scenes, along with the Trigger Sources, which define how the scenes are activated.
- A Scene itself can be thought of as a particular *state* of the FX chains, running under a current session.
- The “Scene” denotes a set of actions to be triggered that put the H9000 into that particular state, either an:
  - FX Chain or Algorithm preset to be loaded into a destination container;
  - A mute/bypass/enable action to be applied to a destination container.
- A “Trigger Source” allows assignment of actions, such as loading a Scene by number, or incrementing and decrementing through Scenes to a MIDI controller.
- You can control Scene changes from the front panel, but usually it will be more convenient to do so from a MIDI controller.

## Trigger Source Options

Scenes can be triggered in the following ways:

### **Load By Number**

Load By Number works like a traditional program change message: it will load whatever Scene matches the number of the program change message you send, between 1 and 128.

Although it usually makes sense to use actual MIDI Program Changes, you can also use Note On or Continuous Controller triggers.

### **Increment/Decrement**

Increment/Decrement switches the H9000 to the next or previous scene, but keeps it in a pending state to be loaded later. The scene can then be loaded by using the “Load Current” function.

**Increment & Load/Decrement & Load:** These functions switch the H9000 to the next or previous scene and then load it immediately

**Note:** If your scenes are nicely sequenced, it’s probably easier to use the Increment & Load/ Decrement & Load options. However, if you need to jump around or skip Scenes, you can use Increment/Decrement with the Load Current option.

Note that if you are using Load By Number, the full range of:

- Program Change
- Note On
- Continuous Controller messages

will be observed and used to determine which Scene to load.

## Working with Scenes

The right-hand side of the screen displays the 128 available scenes, while the left-hand side of the screen displays a list of scenes you have created.

### Create Map

When focused on the left side of the screen, press the *Create Map* button to create a MIDI map of a new scene.



You will be prompted to name the scene, at which point it will be added to the list of created scenes on the left.

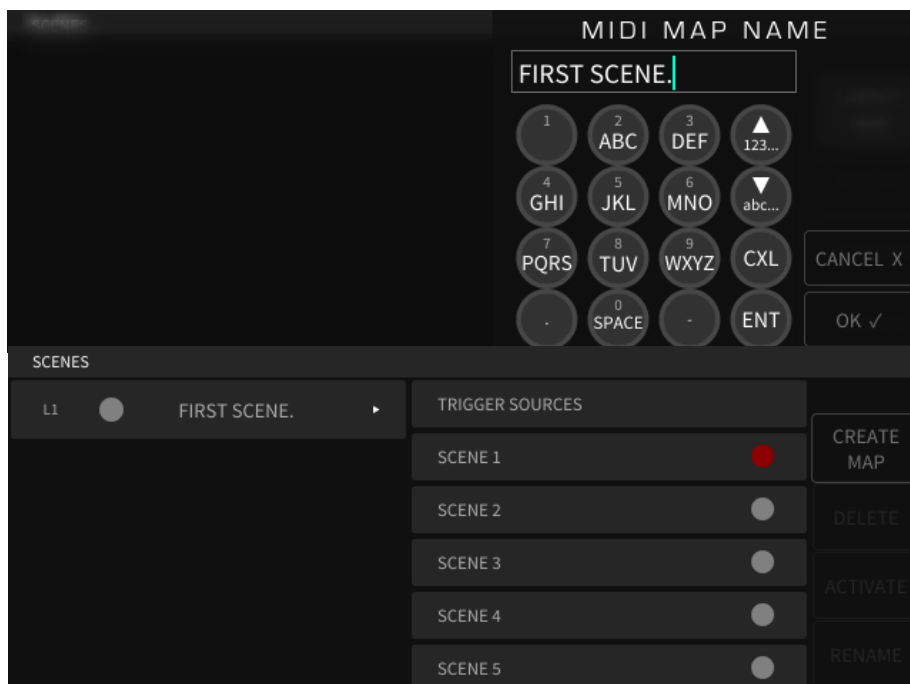

When highlighting any scene in the list on the left, the following soft keys are available for that scene:

### Delete

Press this soft key to delete the highlighted scene.

### Activate

Press this soft key to activate the highlighted scene. The circle to the left of the scene key will turn green, indicating that this scene is now active.

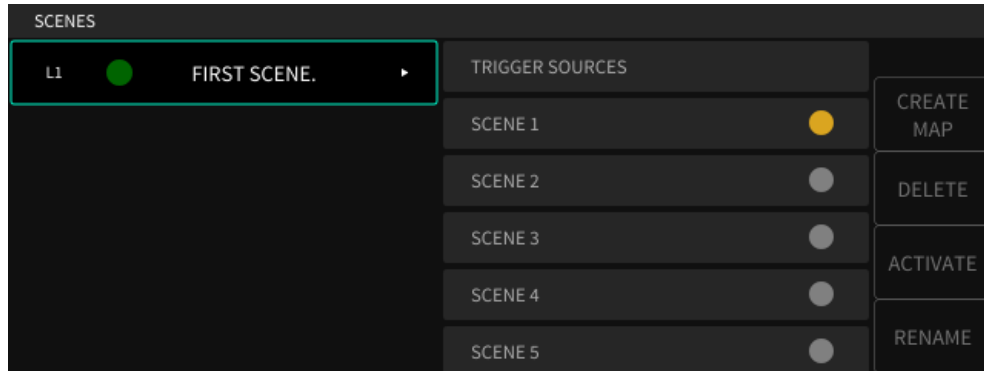

### Rename

Press this soft key to rename the highlighted scene; the naming screen will appear.

### Trigger Sources

The top of the scenes list on the right-hand side contains the *Trigger Sources* function. Highlight this function, then press the *Add Source* soft key.

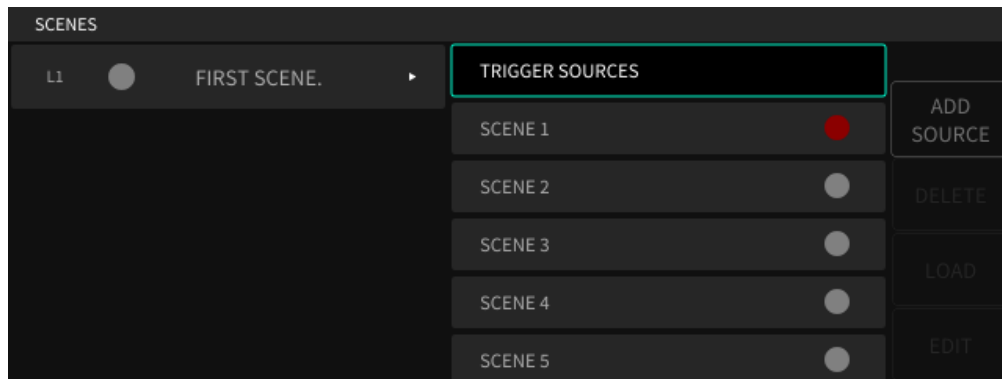



You are presented with the options of:

- Load by number
- Increment
- Increment and load
- Decrement
- Decrement and load
- Load current

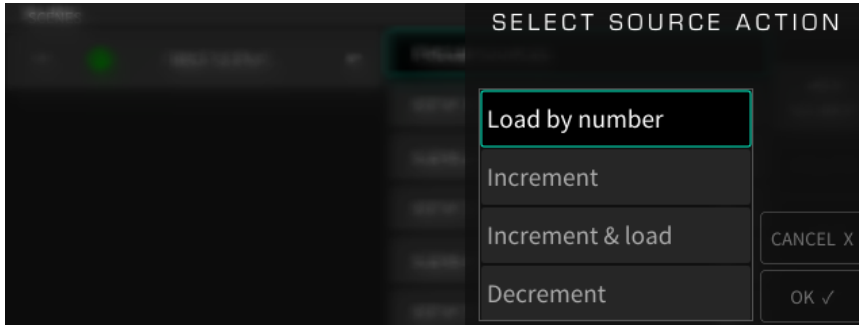

Use the cursor up/down keys or wheel to select an option from the above list, then press the *Enter* key. You will then be presented with the option to trigger the action using:

- Program change
- Note on
- CC (MIDI Continuous Controller)
- Aux switch

### **Add Action**

Highlight a scene on the right-hand side, and press the *Add Action* soft key. You will be presented with the choices of:

- Scene Capture
- Manual

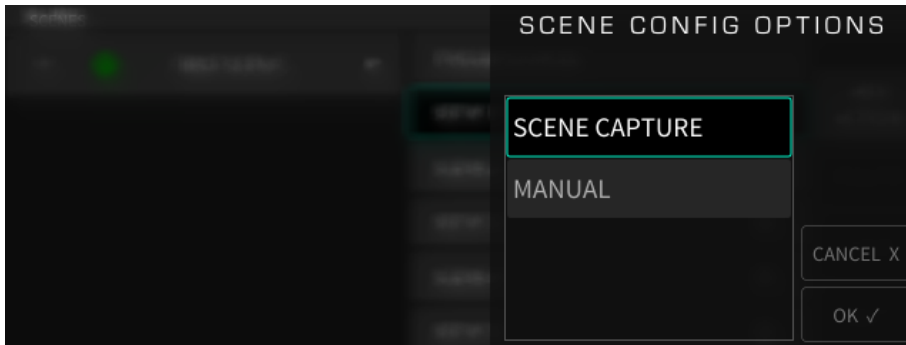

### **Scene Capture:**

This is a way to take a “Snapshot” of the current settings of the Session for a Scene.

### **Manual:**

This allows you to go in and fine-tune the assorted parameters, beforehand.

# Setup

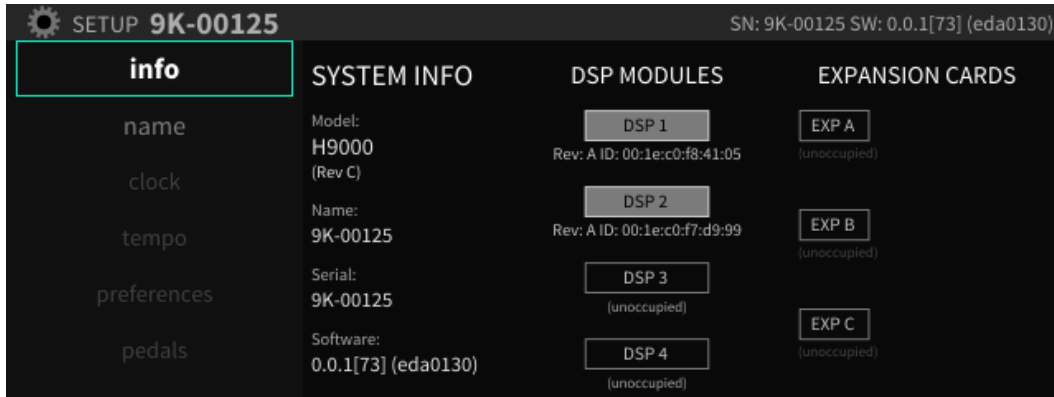

Press the *Setup* button to enter the Setup menus for the H9000. The left-hand side of the display shows a list of different areas you can customize, including:

- Info
- Name
- Clock
- Tempo
- Preferences
- Pedals
- Analog Reference Level
- Network
- Software Update

Use the cursor buttons or wheel to navigate to the setup screen you wish to adjust. The setup category will highlight and the right-hand side of the display will show the specific items that can be adjusted in that section.

## Info

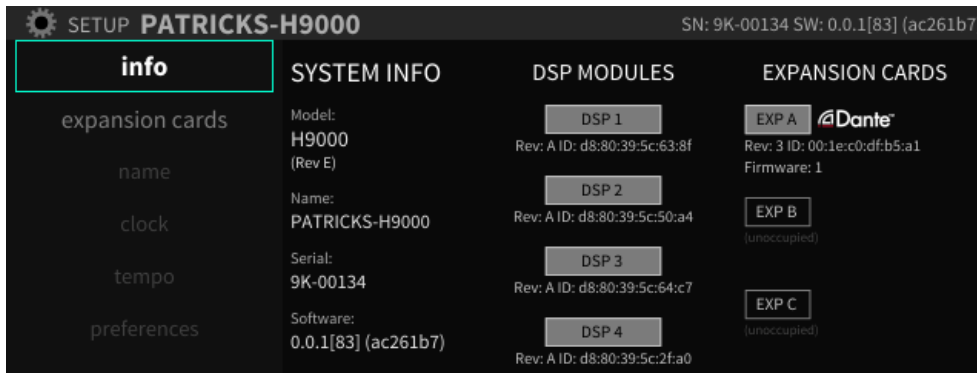

The Info screen is a display only; none of its settings can be adjusted. It provides a high-level overview of your specific H9000 unit, with the following information:

**System Info:** This column displays:

- Model: (In this case the H9000)
- Name: The custom name that you can assign to your unit
- Serial Number
- Software Version

**DSP Modules:** This column displays revision and ID information for the DSP modules installed in your unit.

**Expansion cards:** This column displays information on any expansions cards that are installed in the H9000's three expansion slots (which are labeled slots A, B, and C).

## Name

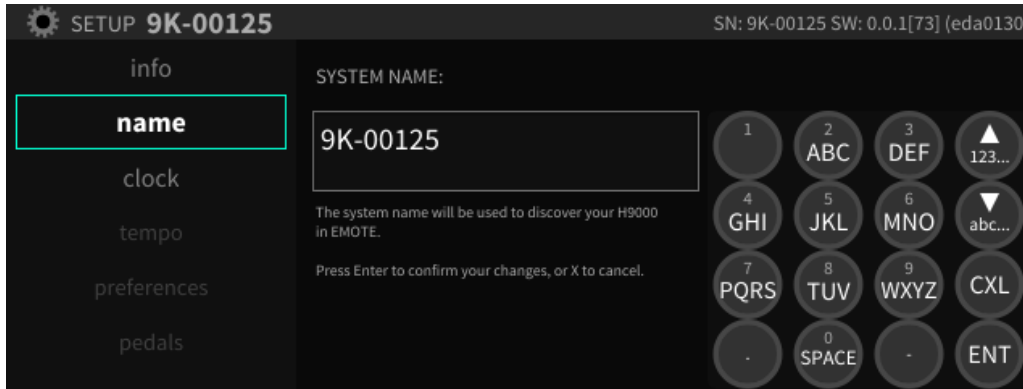

The *Name* screen allows you to create a custom name for your H9000. With custom names assigned, you can easily select the desired unit when using multiple units at the same time and controlling them with Emote.

To assign a custom name to your unit:

- Use the cursor keys to navigate to the *System Name* field
- Press the front panel *Number* keys to enter the letters of the custom name you wish to give your unit.

Each number key has three letters assigned to it, similar to how text entry worked for old-style cellular telephones. Press the number key repeatedly to cycle through each of the three letters.

A “virtual number pad” is displayed, showing you which letters are available on each physical number key.

- Press the arrow down key to toggle between uppercase and lowercase letters.
- Press the arrow up key to toggle between letters and special symbols.
- Press the *Enter* key to save the custom name. You will be asked to confirm your new custom name.
- Press the *OK* soft key to save the name, or *Cancel* to cancel the operation.

## Clock

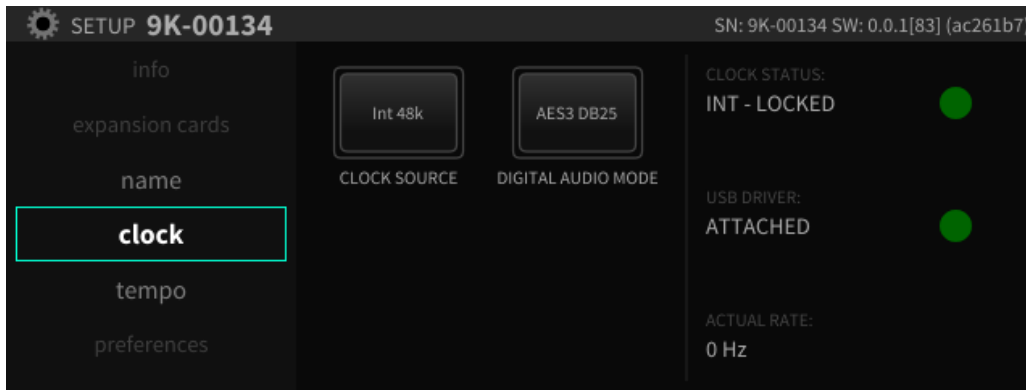

The clock setup menus allow you to set the unit's sample rate and MIDI Clock tempo. Available settings include:

- Clock Source
- Digital Audio Mode
- Clock Status

To adjust the clock source:

- Use the cursor keys to highlight the clock or tempo setting
- Press the *Enter* button or adjust the wheel to reveal up a popup menu with available choices for that setting.
- Use the cursor up/down buttons or wheel to select your desired choice
- Press the enter key again to select that choice.

### **Clock Source**

The clock source is the digital audio clock that your H9000 synchronizes to. You can select an internal clock at various sample rates; alternatively, you can synchronize your H9000's system clock to an external clock signal derived from a wide variety of sources.

Available clock choices include:

- Internal 44.1 kHz
- Internal 48 kHz
- Internal 88.2 kHz
- Internal 96 kHz
- AES Any (any AES signal feeding the 8-channel AES connector)
- S/P DIF/XLR/AES in 1 (Dig 1-2)
- AES In 2 (Dig 3-4)
- AES In 3 (Dig 5/6)
- AES in 4 (Dig 7/8)
- ADAT
- Word Clock (BNC Connector)

### **Digital Audio Mode**

The H9000 contains several different digital audio connectors. However, for simplicity's sake they are "shared" as an input source to any given FX Chain; you choose which one you wish to make active at any time.

The Digital Audio Mode menu is where this selection is made. Use the Digital Audio mode selector to pick your preferred digital audio connector, which will then be available in the audio routing menus of the H9000.

Available choices include:

- AES 3 (DB25 Connector)
- AES 3 (XLR Connector)
- S/P DIF (RCA Connector)
- S/P DIF (Optical Connector)
- ADAT (Optical Connector)

By contrast, for the outputs, the same signal is "mult-ed" to all of the digital audio output connectors simultaneously.

### **Clock Status**

The right-hand side of the screen displays the status of various clocks, as follows:

- Clock Status: The large virtual LED illuminates green when the H9000 is locked to either its internal clock, or a valid external clock that you have told it to slave to.

The LED illuminates red if the H9000 is not locked; for example, if you tell it to slave to an external AES signal, but one is not connected, the LED will illuminate red.

- USB Driver: This field will display as “attached” if the H9000 has a valid USB connection to an attached computer.
- Actual Rate: This field displays the actual sample rate that the H9000 is operating at.

Please note that the H9000 does not support sample rate conversion. If you want to feed the H9000 a digital audio signal, the external digital signal and the H9000 must both be locked to the same digital clock, at the same sample rate.

## Tempo

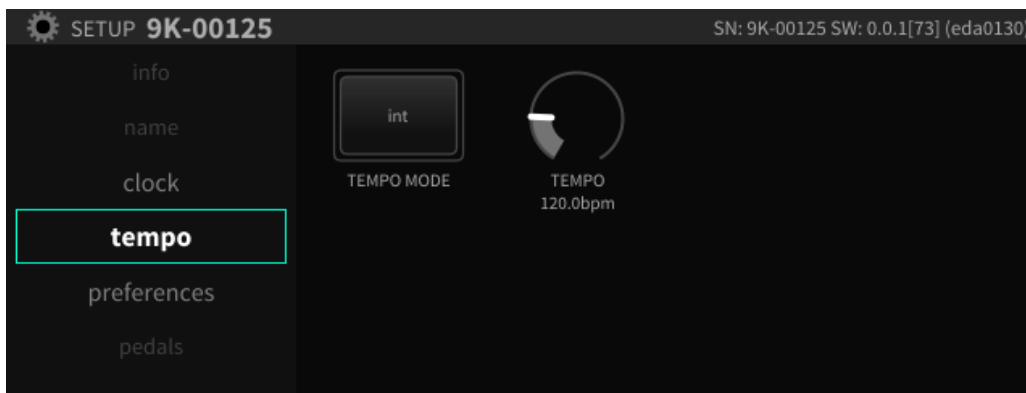

The tempo menu provides controls for setting the H9000's tempo.

The unit's tempo affects the H9000's many time-based effects, which can be synchronized to an incoming MIDI Clock signal. For example, a digital delay line can synchronize the tempo of the delay repeats to an incoming MIDI clock.

**Tempo Mode:** The tempo mode menu includes the following three settings:

- Off: In this mode, no MIDI clock signal is sent to the H9000's MIDI output and no MIDI clock data is received from the MIDI inputs. Any time-based effects will not be synchronized to a MIDI clock signal.
- Internal: In this mode, you set your own tempo, expressed as Beats per Minute (BPM); this BPM value is the tempo base for any relevant time-based effects.

You can set the internal tempo in two different ways:

- *Tap Tempo*: Tap the front panel *Tap* button at least two times; the H9000 will automatically set the unit's internal tempo to the average



of the most recent taps, and temporarily display the tempo in BPM on the display.

The tap function is very useful when using the H9000 in a live sound environment. Simply press the *tap* button in time with the music you are hearing, and then the unit is instantly ready to sync any loaded effects with the song currently being performed.

- *Manual Tempo Adjustment:* (See Below)
- MIDI Clock: In this mode, the H9000 will automatically set the tempo to an incoming MIDI signal feeding the rear panel MIDI input (as long as that MIDI signal contains a valid MIDI clock signal).

**Manual Tempo Dial:** Highlight the Tempo setting, then adjust the wheel to manually select the BPM value you wish to set your tempo to.

## Preferences

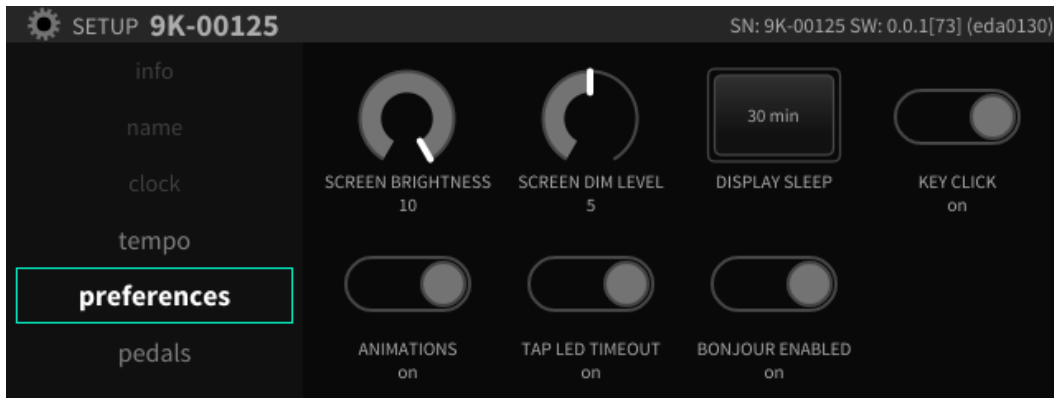

The *Preferences* section controls aspects of the H9000's display, allowing you to customize various aspects of the H9000's user-interface.

Use the cursor keys to highlight the setting you wish to adjust, then use the *Enter* key and/or wheel to adjust the setting.

### Screen Brightness

This control adjusts the brightness of the front panel screen on a scale of 1-10. This allows you to optimize the screen based on your viewing angle and the amount of ambient light in your working environment.

### Screen Dim Level

This setting adjusts the level that the screen dims to when it automatically dims its screen after a set amount of time, dubbed display "sleep". It ranges from being off to "only slightly dimmed".

### Display Sleep

This setting controls the amount of time after which the front panel display will automatically dim.

- Never
- 1 minute
- 5 minutes
- 10 minutes
- 20 minutes
- 30 minutes
- 1 hour
- 2 hours

**Key Click**

This setting toggles on/off an audible click when using the front panel buttons. The click is played from a small internal speaker located inside the H9000.

**Animations**

By default, the H9000 offers assorted onscreen animations for the front panel display. This control toggles the animations on/off.

**Tap LED Timeout**

By default, the front panel *Tap* button flashes in time with the tempo you have set using the front panel Tap button.

Change this setting to “On” if you wish the button to stop flashing a few moments after you have set the tempo.

**Bonjour Enabled**

Turning this setting to “On” configures the H9000 to advertise its services using the “Bonjour” protocol on the local area network.

Bonjour is a zero-configuration network protocol that allows the H9000 to be automatically discovered by the Emote software.

## Pedals

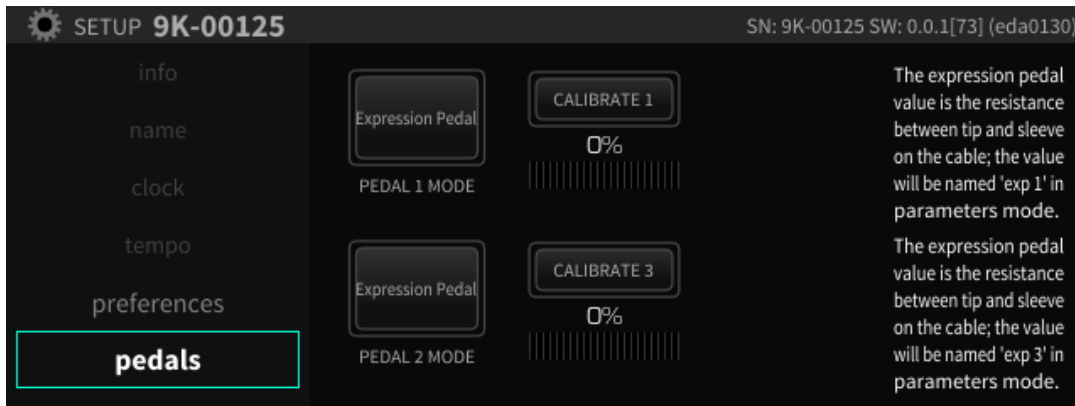

The H9000 allows connection of up to four independent foot pedals; these pedals can be a “switch” type (on/off) or a “continuous” type (volume) pedal.

When setting up an FX Chain and its underlying algorithms, you can map the action of the footswitch/foot pedals to any parameter of your choosing, allowing expressive control of the effects. For example, a guitar player can control the cutoff frequency of a resonant filter using a foot pedal, while playing their instrument.

The *Pedals* setup page allows you to configure your unit for the wide variety of different types of pedals available in the marketplace, taking into consideration factors such as:

- On/Off Switch vs. Continuous pedal
- How many switches on the foot pedal (pedals can range from one to as many as three switches per pedal)
- “Polarity” of the attached pedal

To configure your attached pedal:

- Use the cursor buttons to highlight the “Pedal 1 Mode” or “Pedal 2 Mode” mode.
- Press the *Enter* key, then use the cursor keys or wheel to navigate among the popup menu of options. Available choices include:

- Expression Pedal
- 2 expression Pedals
- 1 Expression Pedal + 1 Aux Switch
- 1 Aux switch + 1 Expression Pedal
- 2 button Aux Switch
- 3 button Aux switch

After you have selected the mode appropriate for your connected switch/pedal, press the *Enter* key to save your selection.

### **Calibrating Your Attached Pedals and Switches**

Once you have selected your desired type of pedal/switch hardware you are using, the H9000 will populate the rest of the display with relevant calibration tools.

- Use the cursor button and the Enter key to navigate to and engage the “Calibrate” field.
- If you have attached an on/off type pedal, physically press on it and make sure that you see the appropriate “SW” circle illuminates. There are separate SW circles for 1, 2 or 3 button pedals.
- If you have attached a continuous foot pedal, navigate to the “Calibrate Pedal” field, then sweep the pedal back and forth with your foot. You should see the Calibrate Pedal field display a range between 0-100% on the calibration meter.
- When you’ve finished calibrating, disengage the “Calibrate” button using the Enter key.

**Note:** Even though there are only two pedal/switch connectors on the H9000, you can connect up to four pedals. This is made possible by connecting two pedals to each connector, using a “Y” cable such as the “Hosa *YPP-117* ¼-inch TRS to Dual ¼-inch TSF Stereo Breakout cable”.

This capability is possible because:

- In the external control section of the parameters mode, there are 4 expression pedals listed.
- In set-up mode, there are options to configure a single connector to be connected to two separate expression pedals.

## Analog Refs

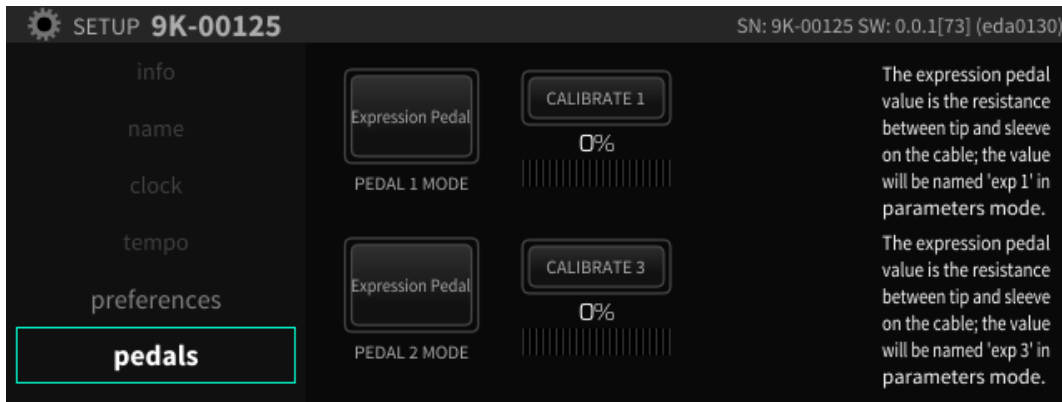

The Analog Reference Levels screen allows you to set the levels for the 8 analog inputs and outputs present on the 25-pin DSUB connector. This allows the H9000 to be installed in a wide variety of environments, and interface at an optimum level with a vast assortment of other equipment.

Each pair of analog inputs and outputs on the DSUB connectors can be separately adjusted between -10dB and +4dB.

Use the cursor buttons to highlight the specific pair of inputs or outputs you wish to adjust. Options include:

- Analog In 1/2
- Analog In 3/4
- Analog In 5/6
- Analog In 7/8
- Analog Out 1/2
- Analog Out 3/4
- Analog Out 5/6
- Analog Out 7/8

Once you have highlighted the appropriate pair of inputs or outputs, press the *Enter* button to switch to the alternate operating level.

Note that the rear panel XLR analog connectors are a duplicate “mult” of channels 1-2 of the 8-channel analog DSUB connectors. As a result, any reference level changes made to analog input or output 1-2 of the DSUB connector will also affect the XLR inputs and outputs.

## Network

The network screen controls settings for connecting your H9000 to a standard Local Area Network. Once connected to a network, the H9000 has the following capabilities:

- Download and install software updates directly from Eventide's servers. Note that your Local Area Network must have Internet access.
- View and control H9000 parameters from the *Emote* software.

The middle column of the network screen shows the available network connections, including:

- Ethernet (for a hard-wired connection)
- Wireless (for a connection using the included Wi-Fi dongle, which can be connected to any of the 4 USB connectors).

### Ethernet Setup

Use the cursor buttons to highlight the Ethernet field in the middle column. The right-hand column will display the parameters of the network you have joined including:

- Network Name
- Network Type (Wired or Wireless)
- IP Address
- Netmask
- Gateway

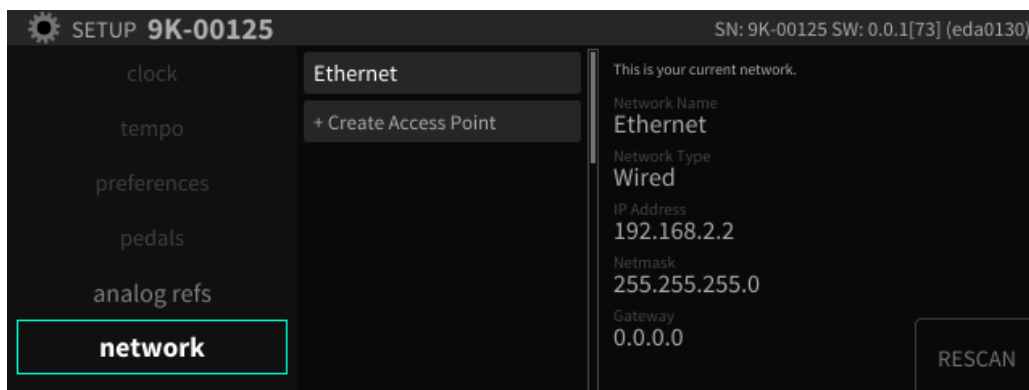

## Wireless Setup

To connect the H9000 to a wireless network:

Connect the included Wi-Fi dongle to one of the H9000's 4 USB ports.

On the network screen, any available wireless networks will be automatically listed beneath the *Ethernet* option.

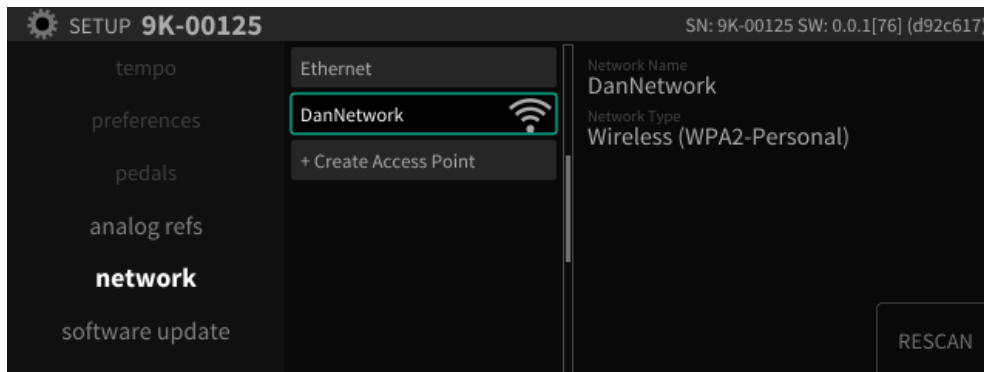

Navigate to the wireless network you wish to connect to and press the *Enter* key.

If the network is not password protected, you will then be connected to the wireless network.

If the network is password protected, you will be prompted to enter in the appropriate password. Use the front panel numbers pad to enter in the password, then press the *OK* soft key.

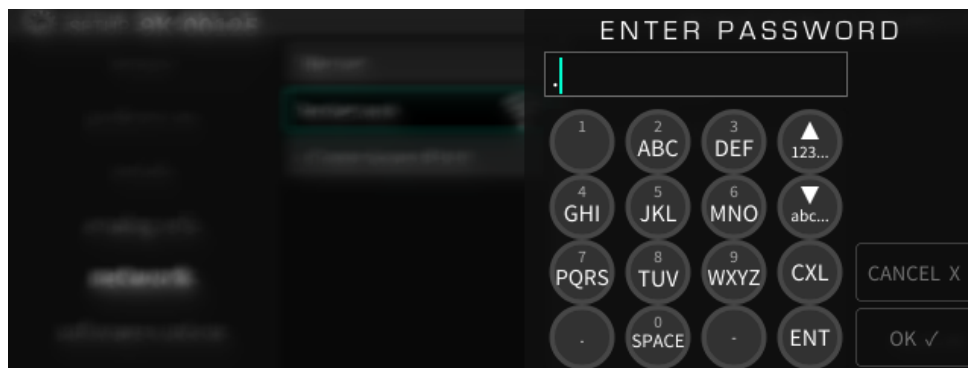

You will then be connected to the Wireless network, and can now use the Emote software to control the H9000.

**Note:** The H9000 stores the authentication settings for the most recently joined network, so if you lose connection for any reason, you can easily re-join the network without having to enter your details again.



### Creating a Local Access Point

The H9000 also has the ability to broadcast its own personal Wi-Fi network, called an “access point”. You can use the Emote software with the H9000 on this private network in environments where there is not an existing LAN for the H9000 and the computer running Emote to connect to each other.

To create an Access Point, highlight the *Create Access Point* field and press *Enter*.

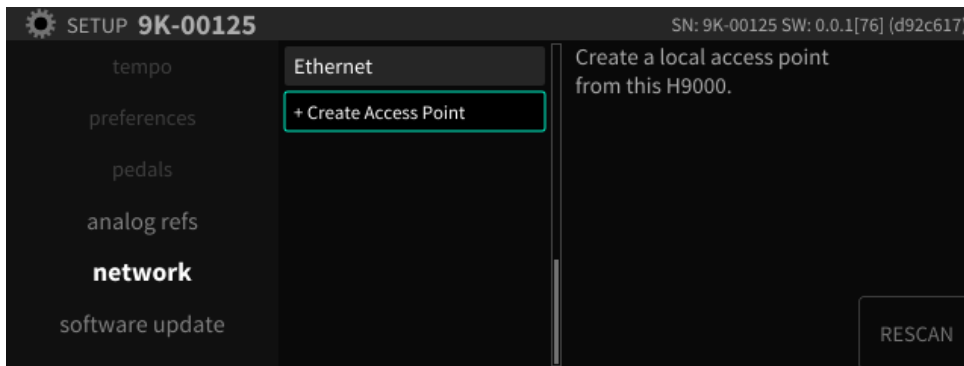

You can choose to enter a password if you wish, or leave the password field blank to create an unprotected network.

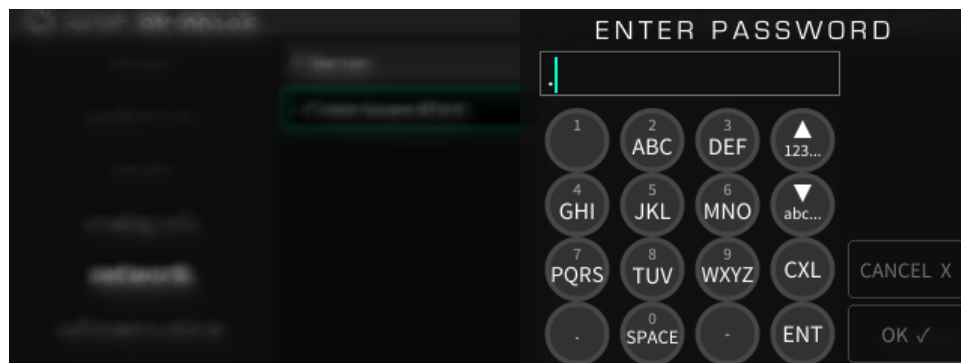

You will then see a message that the Access Point has been created. The Access Point will appear on your computer or mobile device as a Wi-Fi network with the same name as the H9000.

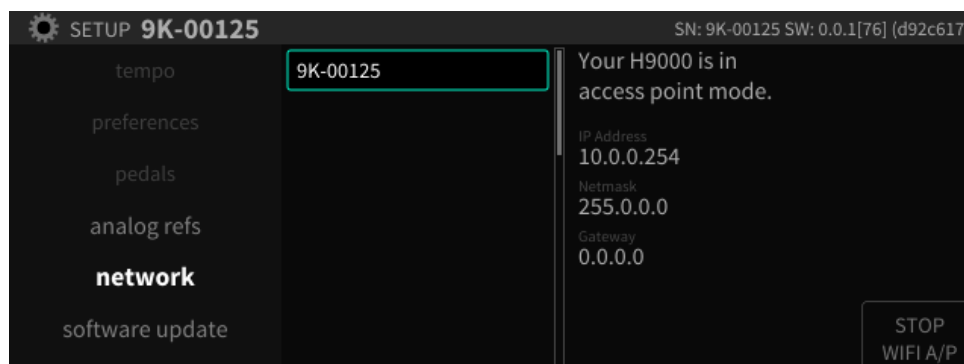

## Software Update

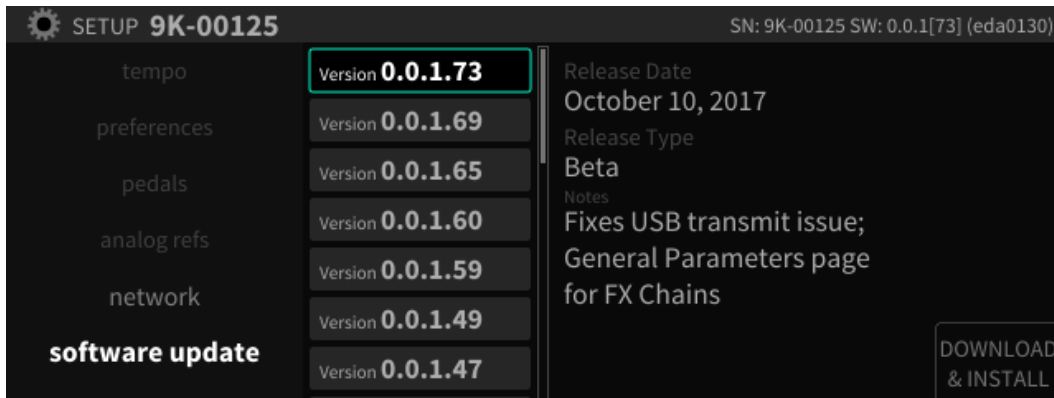

The software update screen allows you to update the software of your H9000 unit quickly and easily. We are always improving the capabilities of the H9000, and this feature ensures that you can always enjoy the latest and greatest capabilities.

To update your unit:

- Please make sure your unit is connected to a network that offers Internet access
- Press the soft key labeled “Download and Install” then follow the onscreen prompts. When the update has been downloaded and installed, you will be prompted to restart your unit to complete the update process.
- **Note:** As a precaution against data corruption which could affect system startup, performing a software update will clear the current state of your H9000. It is advised to save your current session before updating the H9000’s software.

If your H9000 unit is connected to a valid Internet connection and a new update is available, a popup “reminder” message will appear on the display, no matter which screen you are currently on.

**IMPORTANT NOTE:** Please be sure not to interrupt power to your unit during the update process; doing so could damage its internal software, and result in putting the unit into an unbootable state.

In the event this does occur, the H9000 contains a “fail safe” updater that can be used to reinstall the software on your H9000. To use it, perform the following steps:

- Power on the H9000 on with the check and the X keys pressed, it will open the fail-safe updater.

- Your H9000 must either be connected to a network via Ethernet for this to work, or you must have a USB stick connected containing an update file. This file can be obtained by contacting Eventide support to request the latest H9000 software as a USB updateable file.

## Using the H9000 as a Computer Audio Interface

The H9000 can stream 16 inputs and 16 outputs to/from your computer/DAW to serve as a powerful outboard effects processor for your DAW tracks. With this number of separate I/O channels, you could, for example:

- Set up an H9000 reverb effect on an aux send/return of your DAW.
- Set up an H9000 Harmonizer effect on another, separate aux/send return.
- Set up individual specialized effects on multiple DAW channel insert sends/returns.

All at the same time!

**Note:** As of this writing, the H9000 is not currently compatible with Windows-based DAWs. Check back with our website at [www.eventideaudio.com](http://www.eventideaudio.com) regarding future availability of a Windows driver/compatibility.

### Changing the USB audio sample rate

From the point of view of the computer, the H9000 is always the clock master. However, it is not possible for the H9000 to enforce that the sample rate of the computer matches its own. Therefore, the user has to set the sample rates manually. When switching to a new sample rate, you should first change the H9000's sample rate (by selecting a different internal clock source or changing the sample rate of an external source such as ADAT, Dante, etc.), then change the computer's sample rate, for example by loading a session with a different rate or changing the rate in the DAW's preferences. If it detects that the sample rates don't match, the H9000 will mute the USB audio interface and display a warning in the status bar:

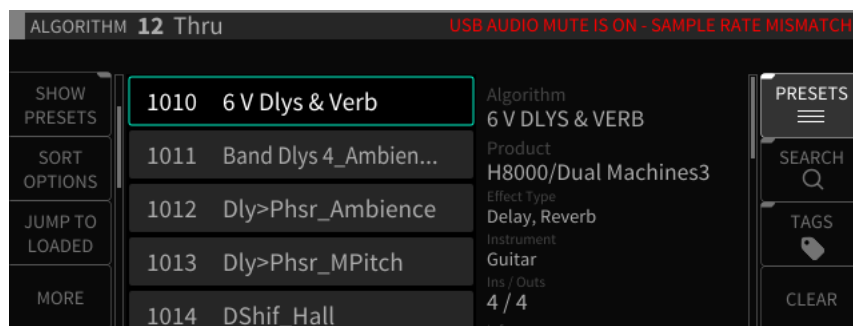

When the sample rates match again, the warning message will be cleared and the audio un-muted.

If you change the sample rate in the DAW first, you will have to change it again once the H9000's clock is changed to match. This is because the H9000 cannot force the computer to re-sync at the new rate - the computer has to initiate this process.

### Using the H9000 with OS X

The H9000 works as a "Plug and Play" Core Audio device in OS X, versions 10.10 and higher. Simply connect a USB cable between the USB B connector on the H9000 and an available USB A port on your OS X computer. No driver installation required!

The H9000 will now be available to all CoreAudio compatible software as a 16-input, 16-output computer audio device, and can be operated at sample rates between 44.1kHz and 96kHz.

### Using the H9000 With Your Existing Computer Audio Interface

The H9000 is an outboard effects processor, and not a traditional, standalone "Computer Audio Interface" with control room monitoring functions. This means that you will likely not have a pair of H9000 outputs patched to your main monitoring system.

As a result, you will likely want to use the H9000's computer connectivity in conjunction with your main computer audio interface (the one that likely does have a main pair of outputs patched into your monitoring setup).

Fortunately, the OS X Core Audio system makes it easy to combine multiple audio interfaces into one large device called an "Aggregate Device". Doing so lets you use your main audio interface and its monitoring capabilities as you always have, while also having the H9000's 16 channels of I/O available to process tracks on your DAW session.

## To Create an Aggregate Device:

- In your applications folder, go to “Utilities”, then launch “AudioMidi Setup”.
- In the “Audio Devices” window that appears, you should see entries for:
  - The H9000
  - Any other computer audio interfaces you have connected
  - The computer’s built in audio output

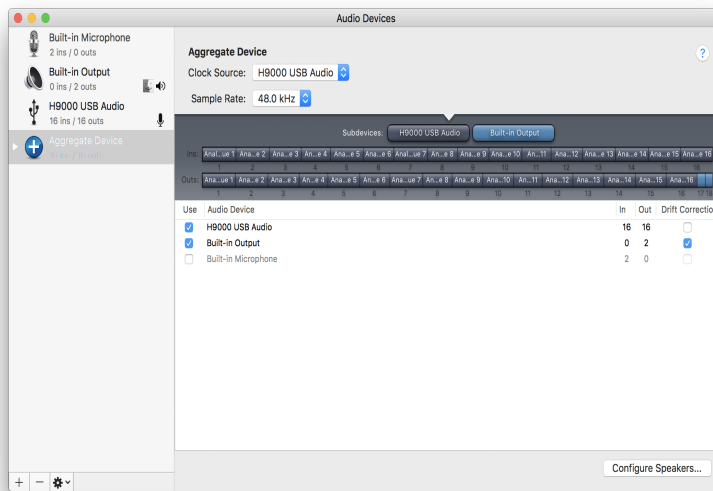

- Click on the “+” Icon in the lower left-hand corner and select “Create Aggregate Device”.
- In the Aggregate Device configuration window that appears, select the appropriate I/O for the different devices you wish to use.
- In your DAW software of choice, select the Aggregate Device as your audio device for the software to use.
- You will now have the I/O of your main audio interface AND the 16-input/output channels of the H9000, all available to use in your DAW session as needed.
- Ensure that the H9000’s sample rate matches the sample rate shown in both:
  - The Audio MIDI Setup window
  - Your DAW session’s

To change the sample rate on your H9000, go to **SETUP>CLOCK>CLOCK SOURCE**. Enjoy using USB Audio with the H9000! You can now have 16 I/O’s with just one simple cable.

# Appendices

## Appendix A: Signal Flow

### Audio Signal Flow

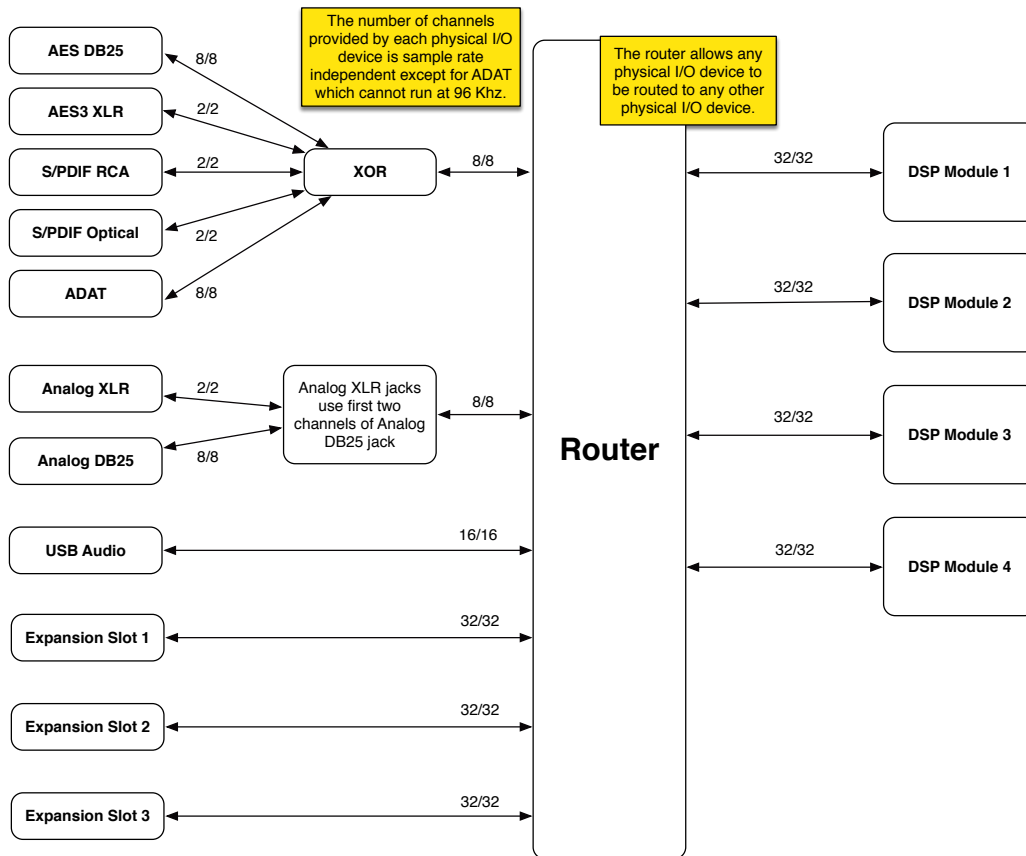

## Control Signal Flow

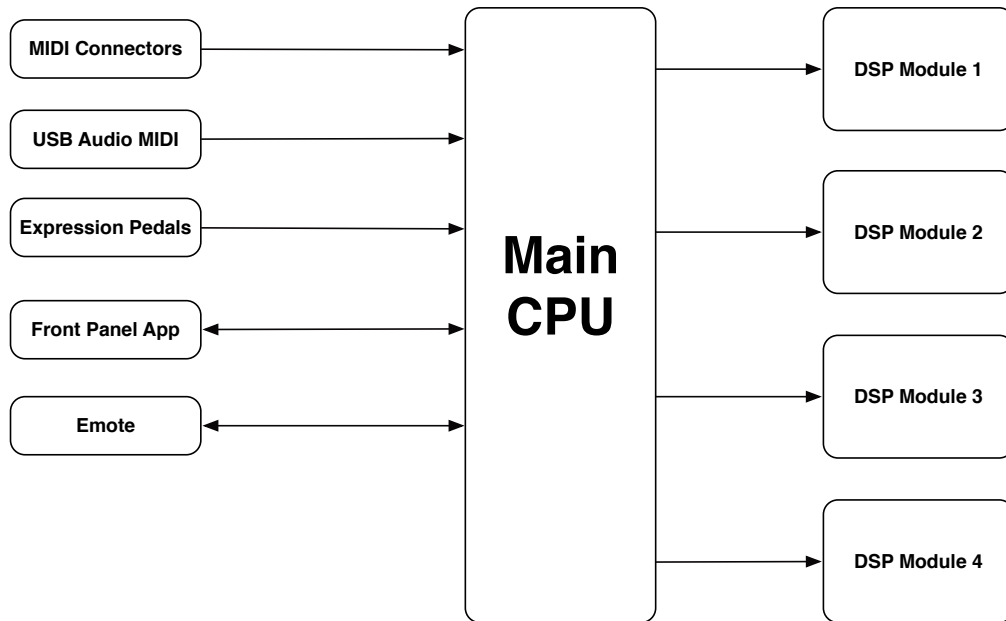



## Appendix B: Startup Sequences

The H9000 contains various “Startup Sequences”. By pressing and holding different button sequences while powering up, you can perform the following functions:

**Soft Reset:** Press the SESSIONS and FX CHAINS buttons for 5 seconds at start-up. This will clear the current state of the H9000, but does not affect any of your stored sessions or presets.

**Factory Reset:** Press the SESSIONS, FXCHAINS, and ALGORITHMS buttons while powering up. This will clear the current state of the H9000, **and will also remove all of your stored sessions or presets**. This operation effectively serves as a “Factory Reset”.

**Fail Safe Updater:** Press the CHECK and X buttons while powering up the unit; this will power up the H9000 into a “Fail Safe Updater” mode.

This mode is useful if a problem occurs when updating the H9000’s software from a network connection using the normal SETUP menu.

If a problem occurs, the fail safe updater can be used to install an update either from a USB stick.

Users can contact [support@eventide.com](mailto:support@eventide.com) to ask for H9000 releases that can be downloaded and installed via USB.

## Appendix C: Word Clock Termination in the H9000

The H9000 has no internal word clock termination, and can be used in the middle of a Word Clock cable without change.

To use it at the end of a word clock chain however, external 50-Ohm termination must be applied. To do this, you will need a BNC T piece, as shown below on the left, as well as a 50-Ohm terminator as shown below on the right.

Connect the T piece to the Word Clock input, the cable end to one side and the terminator to the other side.



### Why is this Necessary?

Any cable has a characteristic impedance that should be matched to both the signal source and destination impedance for best results with high speed sharp edged signals such as Word Clock. This becomes more important with longer cables.

Most Word Clock signals are generated with 50 Ohm source impedance, whereas the BNC cables used to connect to them may have 50 or 75 Ohm impedances; clearly the former are to be preferred.

So, we have covered the source and the cable, but what about the destination? If we only have a single destination it is easy: the destination must also be 50 Ohm, and this is ensured by the use of termination. An input will be either terminated meaning its impedance is set to 50 Ohm, or un-terminated meaning it has a high impedance that will not load the cable.

With multiple destinations only the one at the end of the cable needs to be terminated; intermediate destinations need not and should not be terminated, as long as the “stub length” of the cable to them is short. These should be connected by the use of a BNC “T” connector or splitter attached directly to their inputs so as to ensure the shortest possible stub length.

Using multiple terminations is wrong, both because twice 50 Ohm in parallel gives 25 Ohms, and also because it increases loading on the source.

## Appendix D: H9000 MIDI Functionality

On the H9000, MIDI is always on and received by both the USB ports as well as the MIDI DIN connectors.

The H9000 does not currently transmit or respond to any sysex messages.

Controller functionalities such as omni-channel, note mode, pitch bend range etc. are made at the controller-mapping level, rather than globally.

MIDI Program changes are handled through Scenes mode.

When using the H9000's custom map feature, the following action types are available for note-based MIDI controllers (such as a MIDI keyboard)

- Velocity: Uses the velocity of the selected note as the control value.
- Trigger: Emits a trigger pulse whenever the note is played.
- Toggle: Flips between the min and max values when the note is played.
- Note Number: Uses the whole range of the keyboard, using the note number as the control value.
- Note To Hz: Uses the whole range of the keyboard, and emits a control value equal to the actual frequency of the note being played. This can be useful for “playing” the frequency control of an oscillator or filter.

The “Range” dialog contains 2 range knobs, Control Range and Parameter Range.

- Control Range selects what part of the 0-127 the controller will respond to;
- Parameter Range controls how that value is applied to the parameter it's affecting.

For example, you could use half of the Control Range to sweep the full range of a parameter, or you could use the full Control Range to sweep half the Param Range.

## Appendix E: H9000 Presets

### Band Delay

1	GUITARS IN SPACE
2	OVER THE RAINBOW
3	REGGAE WAHDELAY DARK
4	REGGAE WAHDELAY BRIGHT
5	TIME SLIPS1
6	TIME SLIPS2
7	TIME SLIPS3
8	WAH ECHO1
9	HAW ECHOES1
10	HAW ECHOES2
11	PHASERY BAND
12	PHASERY BAND2
13	LASTFEWBRICKS2

### Black Hole

1	BLACKHOLE
2	DARKMATTER
3	NEBULA
4	NEUTRINO
5	PULSAR
6	CIGAROOS
7	HEY HONEY
8	FISHHOLE
9	TRAIN TRACKS
10	DOGSTAR
11	TRANSFIGURED
12	VORTEXTING
13	CENTAURUS
14	STARCRATER
15	AMEBLACKDRONE

### **Chorus**

WARMTH
POLYMODELICIOUS
SPINNING
PULSATING
70S GUITAR CHORUS
CHORUS BUMPS
LIQUID SWEETENER
BIG CLONE
PHASYCHORUS

### **CrushStation**

1	Fra Diavolo
2	Bisque
3	Sag Harbor
4	Bottom Feeder
5	Jumbo Shrimp
6	Scuttle Butter
7	PunkRock Lobster
8	Steamed in Beer
9	Crawdaddy
10	Decapod Muff

### **Crystals**

1	CLASSIC CRYSTALS
2	SEAGULLS
3	AREYOUTHERE
4	STEAMPUNK
5	FROM A BAD DREAM
6	REVERSE DETUNE
7	PITCH A LA V
8	REVERSELOWS
9	WEIRDBASS
10	NS REVERB
11	EERIE CAVERN
12	VOICE ON ICE

### **Diatonic**

1	STORYTELLER
2	THIRD DREAMING I
3	DELAYED 3RD AND
4	GUITAR TOY
5	OCTAVE LONG DELA
5	WYLD STALLIONS S
6	COPYCATDELAY
7	BASSTOY

### **Digital Delay**

1	PRISTINE DIGITAL DELAY
2	BRIDGE OF SIGHS
3	TWINDELAY
4	COPY CAT
5	WHAT I'M LOOKING FOR
6	1.. AND 2
7	BIG WARM DIGITAL
8	TREM DELAYS
9	DUAL BIG WARM DIGITAL
10	BIG NICE DAY
11	FILTERED DIGITAL
12	CHORUSYTREM
13	FLASER
14	STORM BREWING1
15	STORM BREWING2
16	ANOTHRBRICK1
17	LASTFEWBRICKS1
18	COMFNUMBVERSE
19	RUNRUNRUN

### **DualVerb**

1	DUALVERB
2	HOTSW FREEZE
3	SPACEGALLOP
4	ECHO VERBS

### Ducked Delay

1	VOLUME SWELL HELPER
2	COUNTRY COMPRESSOR
3	THINICE
4	DONTLEAVEME
5	COMFNUMBSOLO

### Dynaverb

1	DYNAVERB
2	TAP-N-TREM
3	RADIO STATIC
4	ADAPT-A-ROOM
5	PHIL MCAVITY
6	AMES DUCK

### EQ Compressor

1	Flat EQ
2	Leo to Les
3	Les to Leo
4	Sweet Home
5	DiscoGuit
6	FunkGuit
7	JazGuitar
8	JCM to Metal
9	Balls
12	ParkedWah
13	AcousticElec
14	Mountain1
15	Bright
16	BassPre
17	BassPre2
18	BassPre3
18	DubBass
19	BassyBass
20	SlapBass1
21	SlapBass2
22	PaulsBass1
23	PaulsBass2
24	Basonex
25	Bootyshaker

26	Walkingbass
27	Walkingbass 2
28	SM58Enhancer
29	SweetVocal
30	VocalPresence
31	Telephony

### **FilterPong**

1	SCHIZO DELAY
2	SPRINGY VERB
3	PONG ECHOES
4	NICE THICK THICKENER
5	WUBBAWUBBAWUB
6	SCIENCE MUSEUM
7	GOOEYFILTEROPONG

### **Flanger**

1	LONG FLYBY
2	BARREL ROLL
3	SUGARFLANGE
4	ROTATOR FLANGE
5	CLASSICFLANGESWEEP
6	CLASSICFLANGESWEEP2
7	PULSINGFLANGE
8	PULSINGWOWFLANGE
9	PULSINGFLANGE2
10	SUBTLEFLANGE
11	PULSERFLANGE
12	SUBTLE-DRASTIC FLANGE
13	SUBTLEFLANGE2



**H910 H949**

1	BALLERINA
2	1984
3	WOMENINLOVE
4	1984
5	3 OCTAVE RANGE
6	POWERCHORD
7	SHATTER
8	PHOTON BEAM
9	INSANITY BUILD
10	RISING SWIM
11	BACKING VOCAL
12	ECHOES OF 910 PAST
13	949 CHORUS
14	DLY1
15	DLY2
16	COUNTRY SLAP
17	SLAP
18	DLYOCTAVE
19	CHNELVOCALS1
20	VOXDLY
21	GUITCHNEL
22	SPICY SPRING
23	BUM-BA-DUM
24	DLYDOTSWEET
25	GUITBASSCHORUS
26	FAT H910

**Hall**

1	EARTH HALL
2	KUBRIX
3	CORRIDORS
4	DARK CAVE
5	DELAYEDPLATE
6	CARNEGIE HALL
7	DOOM CHAMBER
8	PHANTOM VERB
9	VAPOR TRAIL
10	PANOROMANCE
11	HALL
12	HI FI
13	1985

14	CAVE SPACE
15	DISH DELAY
16	TORNADIAN
17	AMEDEO-SLAP

### **HarModulator**

1	TRANCE OCTAVES
2	PSYCHO WAITING
3	FOREBODING
4	CHROMATIC DELAYE
5	VAIBALLERINA
6	ELEC12STRING ROO
7	LIGHTSIDE DARKSI
8	ONE FINGER POWER
9	PHOTON PISTOL
10	PLANET OBELISK
11	BASSGUITSOLO
12	BASS MIN MAJ MOD
13	MUNCHKIN WHALES

### **HarPeggiator**

1	HYPERNOTES ARP
2	GET THEM KIDS MO
3	BASSWITH ARPS
4	BOILINGSOLO
5	BUBBLES
6	DOWNUP
7	FAKE SHREDDING
8	INTELLIVISION
9	LIGHTEMUP
10	MACHINES
11	MENACE
12	SPACETREM
13	TREMBOT
14	MOLTEN
15	BIGCHILL
16	OLD VIDEO GAME
17	RAVE VOCALS

### **Looper**

1	Basic Looper
2	16 Beat Auto Loop
3	16 Beat Reverse Start
4	Dub Decay Looper
5	8 Beat Punch
6	8 Beat Punch Replace
7	Thin Loop
8	Long Basic Looper
9	48 Beat Basic Looper
10	LoFi 16 Beat

### **MangledVerb**

1	MANGLEDVERB
2	FLUFFER
3	OBLIVION
4	SANSKRITUAL1
5	SCREAMWARP
6	REVUNCHED
7	MANGLEDVERN
8	DOOMDRIVE
9	DRIVEDOOM

### **MicroPitch**

1	H3000
2	NICECHORUS
3	VIBRACHORUS
4	CHORUS ROOM
5	SLAP MY ECHO
6	DARKECHOES
7	SPACEY SPRINGS
8	ELEVATOR DELAYS
9	BASSCHORUS(ES)
10	BOTTOMLESS DROP

**Mod Delay**

1	EVERY LEAD YOU FAKE
2	LOST LUNCH
3	PEDAL PITCH
4	1.. AND 2 MOD
5	LAZYPHASY
6	FUNK ECHO
7	PHASERECHO1
8	PHASERECHO2
9	CREEPY
10	CHORUSPHASE NO DELAY

**ModEchoVerb**

1	MODECHOVERB
2	EKOSPACE-GOD
3	SOLARDELAY
4	AMBIENCE
5	FLANGE TILES
6	MATRIX DECAY
7	PLANETARIUM1
8	JUNGLEAPPETITE

**ModFilter**

1	BASS AUTO WAH
2	JUPITER REACTS
3	NERVOUS FILTER
4	HYPERWAH
5	WATERYFILTER DARK
6	WATERYFILTERBRIGHT
7	BUBBLYFILTER
8	TREMMODFILTER

### MultiTap

1	AIRPLANE HANGER
2	GHOST TOWN
3	500 SEATER
4	BIG SWELLPAD1
5	MULTI HALL
6	AMBIENT MULTI
7	MULTI WETLIVE
8	GALLOPER MULTI
9	TAPPER
10	STRUMMER
11	STRUMMER2
12	KING'S MISSILE
13	AUTOMARCH
14	EMPTYSPACE
15	WORMS

### Octaver

1	NAZZTYBASS
2	THROATYBASS
3	WAHELECTRONIQUE
4	CRAB BASS
5	CLASSIC OCTAVER
6	MASSIVUZZ
7	OCTOFUZZVER
8	BASS VOWELER GRO
9	DRTY VOCALS

### Phaser

1	FUNKPHASE
2	AIN'T TALKIN 'BOUT PHASE
3	PHASER WAH
4	LOU-NIVIBE
5	VIBRAPHASER
6	SAWMODPHASER
7	STOPPEDPHASE
8	PHAT PHASE

### **PitchFlex**

1	OCTAVE FLEXSWITC
2	FLEX HARMONY -1O
3	FLEX HARMONY -5T
4	FLEX HARMONY -4T
5	FLEX HARMONY +5T
6	FLEX HARMONY +4T
7	FLEX HARMONY +3R
8	FLEX HARMONY +FL
9	FLEX HARMONY +2N
10	PITCH FLEX +1OCT
11	PITCH FLEX +2OCT
12	PITCH FLEX -1OCT
13	PITCH FLEX -2OCT
14	PITCH FLEX -2ND
15	PITCH FLEX -4TH
16	PITCH FLEX UNISO

### **PitchFuzz**

1	Just the Fuzz
2	WholeLottaPeach
3	Peach Dog
4	HOT MCADAM
5	Chorus and Delay
6	Arpeggiate
7	PEACH SLAP
8	CHERUB
9	HARP CHORDS
10	Peaches KICK IT
11	ORGANIZOR
12	Dovers Peach
13	LawfulKnowledge
14	OhYouAteOneToo
15	Atmospheres
16	MIMA LEAD
17	SUSPENDED PEACH
18	PEACH-TAVIA
19	Fripper Fuzz
20	R U Fuzz
21	COPELAND
22	COBBLER TRIADS

23	FUZZSTACK
24	Lethal Weapon 7
25	Schnapps
26	Goof Delays
27	Delicate Trinkets
28	Muscle
29	Pitch Busters
30	Weird Orchestra
31	Space Peach
32	FruitInTheRain
33	Working Man Bass
34	JUICED UP BASS
35	Boogie Oogie Bass
36	BIG BASS SYNTH

### Plate

1	PLATE
2	GUITPLATE
3	OILDRUM
4	DINNER PLATE
5	JUST CUZ
6	PRESSURE
7	SIFT PLATE
8	CENTAURI

### Q-Wah

1	LAZYPHASYWAH
2	SQUAREMODWAH
3	TALKING BACK
4	OTTAWAH
5	MUMBLER
6	VINTAGE WAH
7	PHASYWAH
8	LESSEVENAUTOWAH
9	NERVOUS WAH
10	SLOWSWEEPWITHTREATS
11	BIGMODDEDPLANETSWEET
12	SOFTCHOPPER
13	WAH-BRAVIBE
14	VIBRAPHASYWAH

### **Quadravox**

1	TEENAGE WASTELAN
2	ANTHEM
3	BANJO STRUMMER
4	GOOD MORNING SUN
5	MOODSWITCH
6	IF IT'S BAROQUE
7	GUITARHARP
8	PITCHDRAMA
9	HEAVY QUAD OCTAV

### **Resonator**

1	SPELUNKING
2	FILTERED MULTITAP
3	SAVERENCE
4	RESOVERB
5	GUMDROP
6	SUBMERGED
7	TRANSCENDENTAL DOLPHIN
8	SCARY CHORD
9	CLEAN DELAY
10	BEECUZ
11	RENO
12	TICK TOCK
13	RAAG MALHAR
14	CAVERN
15	ELECTRONS
16	THE BEAUTIFUL
17	ANDY WARHOL ON THE RUN
18	CASCADE
19	DISSONANT REPEATER
20	THOR'S BELLS



### Reverse

1	BACKWARDS RIFFS
2	ETHEREAL ECHOES
3	DRING MODULATOR
4	REVERSE FLUTTERS
5	REVERSE FLUTTERS2
6	REVERSE SPACE
7	BACKWARDS ALL
8	REVERSE SPACE2
9	BACKWARDS ALL2
10	REVERSE SPACE3
11	REVERSE NO CRYSTALS
12	INSIDE OUT
13	RAMP UP REVERSE

### Reverse Reverb

1	REVERSE
2	SPINDIZZY
3	CONTINUUM
4	TWEET OFF
5	REFLEXIVE
6	GHOST PLATE
7	ALIEN VERB
8	GARBLE SPACE

### RingMod

1	WHAT'S THAT SMELL
2	GUITAR DRUMS
3	HELLSBELLS
4	STATIC
5	ELECTRICITYRING
6	RING'S TREM
7	RING'S LESLIE FAST
8	RING'S LESLIE SLOW
9	RING'S CHORUS
10	RING'S TREM2
11	RING'S TREM 2 FASTER
12	TREM TURNS UGLY
13	INTERFERENCE
14	BUZZBELLS

### Room

1	ROOM
2	BOXY ROOM
3	PCM60ROOM
4	GUITAR ROOM
5	LUX SPACE
6	SHUTTER ROOM
7	CANISMAJOR
8	ROOM 667

### Rotary

1	SLOWLY ROTATE
2	WHIRLING DERVISH
3	BIG FAT CABINET
4	HYPER ROTOR
5	JAZZYROTARY
6	TREBLE SPIN
7	BASSSTILLROTARY
8	AUTOFASTSLOWROTARY
9	AUTOFASTSLOWROTARY2
10	OLDTYME RADIO
11	SPACESHIP ROTARY

### Sculpt

1	Sculpt
2	Wahvolver
3	Dirt Boost
4	Butter Churner
5	Little Speaker
6	Fuzzy Pillow
7	Land O Lakes
8	Embwhass
9	Honki Tonki
9	UFO Shred
11	Chisel
12	Jazzy Box
14	Airbag
15	Wizards Tele
16	Dissect
17	AntiWah

17	Meow Wow
18	Rumble Down Lo
19	Sculpt Da Bass
20	MuthaShip Connect
21	Funke Biass

### **Shimmer**

1	SHIMMER
2	MOUNTAINS
3	IRONWORX
4	TOUCHED BY AN H9
5	HELLS GATE
6	SIZE MATTERS
7	SNEAKY VERB
8	QUASAR
9	DARK ANGELS
10	NEROS ASCENT
11	GUNSHOT SNARE
12	DEMON CALL
13	AMEDEO-BASS-SHIM

### **SpaceTime**

1	SpaceTime
2	Nice Chorus
3	Space Cathedral
4	Quarter Delay
5	Faux Leslie
6	Verb Repeats Only
7	Small Tight Room
8	Parallel Delays
9	Aphelion
10	Slap in Space
11	IntaStella
12	Off the Ground
13	Shadows
14	Voyage
15	TwilightZoned
16	Sunlight
17	HUBBLE
18	On the Verge

19	EventHorizon
20	Gravitation
22	ExtraTerrestrial
23	Outer Limits
24	Star Sailor

### Spring

1	SPRING
2	RW TANK
3	SPRINGTHEORY
4	SPICY SPRING
5	BIG BALLS
6	DARK SPRING
7	GUTTER FLANGE
8	AMESPRING

### Synthonizer

1	MOTORBIKE LEAD
2	FLUTEFACTOR
3	TROMBONEFACTOR
4	WELCOME TO THE M
5	BASSIC SYNTH

### TapeEcho

1	LENNON SLAP
2	FIBONACCI TAPE
3	TAPE FOR VOCALS
4	CLASSIC SLAP
5	RECORD HEAD
6	BE WOWED
7	MULTI SLAP
8	REELTOREEL
9	FLUTTERWOW
10	TAPEDRONE
11	WARPED RECORD

### **TremoloPan**

1	I WALK ALONE
2	TUMBLEWEED TREM
3	RAMPCHOPPER
4	SQUARE CHOPPER
5	SPECIAL AGENT FACTOR
6	FLUTTER TREM
7	PULSING TREM
8	PANNING TREMO
9	MODACITY
10	HYPERCHOPTREM
11	CHOPPER TREM

### **TremeloVerb**

1	TREMOLOVERB
2	BROKEN GLITCH
3	HORROR SHOW
4	SPLITTER VERB
5	ABITSHAKEY
6	AMETREMVERB1
7	AMETREMVERB2

### **UltraTap**

1	ULTRATAP
2	BATMAN
3	BOUNCING BALL
4	GHOSTHUNTER
5	MOSQUITO
6	DISAPPEARING HALL
7	STUTTER
8	SLOWING DOWN
9	ULTRASWELL
10	ZIPPERVERB
11	CHOP HALL
12	SIX PULSING
13	HUH FLANGE
14	FOLLOW ME
15	CLOCKWORKS
16	NANO STUDDER
17	SYNTH GHOSTS

18	BULLFROG
19	TAPSLAP
20	GLITCHTRIGGER

### **Undulator**

1	QUADRUPLE PEAKS
2	NEVER THERE
3	LONESOME TRAIL
4	TIME LAPSE
5	CHOPDULATOR
6	TREMDULATOR
7	DREAMDULATOR
8	DREAMYDREAMULATOR
9	DREAMYDREAMULATOR2

### **Vibrato**

1	SWAMP MOON
2	WARPED VINYL
3	DYNAVIBRATO
4	QUIVERER
5	VIBRAVIBE
6	VIBRAVIBE2
7	VIBRAVIBY
8	VIBRAPHASER2

### **Vintage Delay**

1	STREETS
2	AMBIENT VINTAGE
3	FOUNDIT
4	LONG VINTAGE H9
5	VINTAGE VOCAL
6	ROTTEN OLD DELAY
7	LO-REZ TRAIL
8	SLAPVINTAGE
9	CLASSIC CHORUS
10	LONG OLD DELAYS
11	UBETTERRUN
12	NICE OLD ECHOES
13	VINTAGE FILTERED ECHOES

14	WHERE THE AVENUES HAVE NO NAME
15	LONG VINTAGE2
16	TWO VINTAGE ECHOES

## Appendix F: H9000 Algorithms

Preset	Name	I n s	O u t s
11	Mute	4	4
12	Thru	8	8
13	Oscillator (440)	2	8
14	Note Oscillator	4	4
210	Amp-u-lation	2	2
211	AMS DMX Guitar	2	2
212	AMS Lucky Man	2	2
213	BackwardGarden3	2	2
214	BadBadThing	2	2
215	Big Muff W/ Dead 9v	2	2
216	Enhancer	2	2
217	Garden Halo	2	2
218	Gorgeous Delay	2	2
219	ImpWave	2	2
220	Jan's ResoChords	2	2
221	JP Em +3rd	2	2
222	JP Em +3rd/+6th	2	2
223	JP Em +6th	2	2
224	Kill The Guy	2	2
225	Little Man	2	2
226	Mandel Worlds	2	2
227	Maniac Filterpan	2	2
228	Old Valve	2	2
229	Panner Delays	2	2
230	Random Verb Long	2	2
231	Satchelope Filter	2	2
232	SatelliteSax	2	2
233	Seethy Two Reverb	2	2
234	SonicDisorderVerb	2	2
235	Treys Filter	2	2
236	Vai Shift 1	2	2
237	Vai Shift 2	2	2
238	W-I-D-E Solo	2	2
239	Water-like	2	2
240	Whirly Mellow	2	2
241	Wicked	2	2



310	8 Delays	8	8
311	4 Diatonicshifts	4	4
312	8 Diatonicshifts	8	8
313	4 Pitchshifters	4	4
314	8 Pitchshifters	8	8
315	BasicRoom	2	4
316	Compressor_8	8	8
317	Diatonicshift_O	8	8
318	Diatonicshift_Q	4	4
319	Filter_O	8	8
320	Filter_Q	4	4
321	Pitchshifters_O	8	8
322	Pitchshifters_Q	4	4
323	Octal Compressor	8	8
324	Quad Compressor	4	4
325	Octal Delays	8	8
326	Quad Delays	4	4
327	Octal Moddelays	8	8
328	Simple Moddelays	4	4
330	4*10 Grafic Eq	4	4
331	8*10 Grafic Eq	8	8
332	O*10 Grafic Eq	8	8
333	Q*10 Grafic Eq	4	4
334	O*5 Grafic Eq	8	8
410	Gaspodes Dly_2	3	2
411	Gaspodes Dly_M	2	2
412	Gaspodes Dly_S	2	2
413	Gaspodes Pndly_D	3	4
414	Gaspodes Pndly_M	2	2
415	General Informations	2	2
510	Delaytaps	2	2
511	Delaytaps 2	4	4
512	Demondelay	2	2
513	Ducked Delays	2	2
514	DuellingDualDlys	8	8
515	Envelope Taps	2	2
516	Eight Delays	8	8
517	Eight Longdelays	8	8
518	EightReversedelays	8	8
519	LongDelay	2	2
520	MonoDelay	2	2

521	Multitap Delay	2	2
522	Parallel Delays	2	2
523	Parallel Dlys 8ch	8	8
524	Pingpong	2	2
525	Polyrhythm 5/4	2	2
526	Precision Delays	2	2
527	Reverse Delay	2	2
528	Ribbon Delay	8	8
529	SimpleDelays	2	2
530	SimplePingPong	2	2
531	Smear	2	2
532	SuperDuckedDelays	2	2
533	Two Delays	2	4
534	Two Longdelays	2	4
535	Two Reversedelays	2	4
536	Video Delay 8	8	8
537	1x8 Delay	8	8
610	Banddelays	2	2
611	Band Delays 8ch	8	8
612	Bandtaps	2	2
613	Bandtaps2	4	4
615	Centering Echoes	2	2
616	ChordRezonator8ch	8	8
617	Clearmntn Claps	2	2
618	Clearmntn Delays	2	2
619	Combdelays	2	2
620	Combdelays 8ch	8	8
621	Combtaps	2	2
622	Combtaps2	4	4
623	Detuned Band Delay	2	2
624	Down Banddelay	2	2
625	Latticework8	8	8
626	LongPanningDelays	4	4
627	LongPanningDelays8	8	8
628	Mess With Stereo	2	2
629	PanningDelays_4	4	4
630	PanningDelays_8	8	8
631	ParticleAccelerator	2	2
632	Pingcombpong	2	2
633	Pingringpong	2	2
634	Ringdelays	2	2

635	Ringdelays 8ch	8	8
636	Ringtaps	2	2
637	Ringtaps2	4	4
639	Samp/Hold Smear	2	2
640	Trem + Delay	2	2
641	TrippyFltrDly	2	4
642	Up Banddelay	2	2
650	4 I/O Delays	4	4
651	Filtered Dlys	2	2
652	Quad Delays AmbienceEmpty	4	4
653	Quad Echoes	4	4
654	Vintage Delay	2	2
655	Vintage St DuckDlys	2	2
656	DP Ducked Dlys	2	2
657	TK's Banddelays	2	2
658	Bulge Tales	2	2
660	5.1 Banddelays	6	6
661	5.1 Ringdelays	6	6
662	5.1 Reso>Verb	6	6
663	5.1 ResoChords	6	6
664	5.1 Mangling Dlys	6	6
665	5.1 Diffused Echoes	6	6
666	5.1 Diffechorus	6	6
667	5.1 Combdelays	6	6
668	Mangling_Dlys	2	2
670	5.1 Clearmntn Delays	6	6
671	5.1 Colortaps	6	6
710	Fractal Vortex	2	2
711	Helix Loops	4	4
713	Levitation Alpha	4	4
714	Levitation Beta	4	4
715	Levitation Gamma	4	4
717	Manifold Alpha	2	2
718	Manifold Beta	2	2
719	Mobius Loops	4	4
721	Panning Loops	4	4
722	PhaseRefraction1	2	4
723	PhaseRefraction2	2	4
724	Reich Loops 1	4	4
725	Reich Loops 2	4	4
726	Reich Loops 3	4	4

727	Rotation Loop	4	4
729	Skew Loop 1	2	2
730	Skew Loop 2	2	2
732	Undoloop	2	2
733	YourHarmonyDevice	2	2
734	4 Tracker#3	2	2
735	4 Tracker#4	2	2
736	4 Tracker#5	2	4
740	5.1 Loop & Freeze	6	6
741	5.1 Soundscapes	6	6
742	Soundscapes	4	4
743	5.1 Loops > Colors	6	6
744	5.1Loops>ModdtunersEmpty	6	6
745	5.1 Loops > XF Mod	6	6
810	'Static' Flanger	2	4
811	Allan's Chorus	2	2
812	Auto Tape Flanger	2	2
813	Band Flanger	2	4
814	Chordal Swell	2	2
815	Chorusdelays	2	2
816	Chorusdelays 8ch	8	8
817	Chorused Cabinet	2	2
818	Chorused Delays	2	2
819	Chorustaps	2	2
820	Chorustaps 2	4	4
821	Detune Chorus	2	2
822	Drew'sThroatflange	2	2
823	Drunken Sailor	4	4
824	DualChorus	2	2
825	DualChorusDelays	2	2
826	Envelope Flanger	4	4
827	Envelope Flanger 8	8	8
828	Flange Echoes	2	2
829	Flanged Delays	2	2
830	Hiccup Chorus	2	2
831	Infinite Flange	2	4
832	Leslie Simulator	2	2
833	Pan Chorus's	2	2
834	Panning Delays	2	2
835	Pingchoruspong	2	2
836	Polymod Chorus	2	2

837	Polymod Delay	2	2
838	Pure Comb Flange	4	4
839	Pure Comb Flange8	8	8
840	QuantizedDelays	2	2
841	Real Chorus	2	2
842	Real Chorus TNG	2	2
843	S&H Flange Hell	4	4
844	Serial Delays	2	2
845	Stereo Chorus	2	2
846	Stereo Flange	2	2
847	Stereo Flange 1968	2	2
848	StringPadFlanger	4	4
849	StringPadFlanger	8	8
850	Swirl Flanges	2	2
851	Tri Band Chorus	2	2
852	Undulate	2	2
853	OctalChorusEchos	4	4
854	ChorusEchos 8ch	8	8
855	4v Random XF Chorus	2	2
856	DPFiltered XF DelaysEmpty	2	2
857	Random XF Flanger	2	2
858	What a Flanger 8ch	8	8
859	5.1 Random XFChorus	6	6
860	5.1 Chorus	6	6
861	5.1 Circling Delays	6	6
862	5.1 Detuned Echoes	6	6
863	5.1 Flanger	6	6
864	5.1 Fr/Sur Bounce	6	6
865	5.1 Rotation Delays	6	6
866	5.1 Vintage Delays	6	6
867	5.1 DP Filtrd XFDlysEmpty	6	6
868	5.1 Random XFDelays	6	6
869	5.1 Random XFFlangerEmpty	6	6
870	4 I/O ModDelays	4	4
871	Dual 2taps Chorus	2	2
872	Dual 2taps Delay	2	2
873	Dual 2taps Echorus	2	2
874	Stereo Chorus	2	2
875	Lucy In The Sky	2	2
876	Flanged Space 1	2	2
877	EchoMatic	2	2

878	Delays Matrix	2	2
879	AmbiClouds 2	2	2
880	Vibropad	2	2
881	Chors'n'Echo	2	2
882	Chorusdelays2	4	4
909	5.1 Distortion	6	6
910	DesertPercussion1	2	4
911	DesertPercussion2	2	2
912	Neutralizer	2	2
913	St BitDecimator	2	2
914	St DistortionTwo	2	2
915	St_Distortion	2	2
916	Comb Distortion	2	2
1010	6 V Dlys & Verb	4	4
1011	Band Dlys 4_AmbienceEmpty	4	4
1012	Dly>Phsr_Ambience	4	4
1013	Dly>Phsr_MPitch	4	4
1014	DShif_Hall	4	4
1015	Dtune_Hall	4	4
1016	Dtune_VinDly	4	4
1017	DynoMyPiano_Ambiencehead m	4	4
1018	DynoMyPiano_VintDlysheadm	4	4
1019	FltDlys_Rich Chamber	4	4
1020	Hall_Dual 2Tap Dly	4	4
1021	Modulation Suite	4	4
1022	Piano & Vocal Halls	4	4
1023	Snare Plate&Inverse	4	4
1024	Vox Pro_VintDly	4	4
1030	2 Stereo Verbs	4	4
1031	2 St.verbs(mixed)	4	2
1032	4 Stereo Verbs	8	8
1033	4 Stereo Verbs 2	8	8
1034	AMSDMX/2BPMDDLs	4	4
1035	AMS/BPMDDLsmixed	4	2
1036	Midi Dual FX #1	4	4
1037	Midi Dual FX #3	4	4
1038	Midi Dual FX #2	4	4
1039	Midi Dual FX #4	4	4
1040	Midi Dual FX #5	4	4
1041	Midi Dual FX #6	4	4

1050	1980Chorus_DPFItDlyEmpty	4	4
1051	4RanXFChrs_DPDUckDlyEmpty	4	4
1052	DPDUckDlys_ModDetnrs	4	4
1053	New Room_1980 Chorus	4	4
1054	New Room_DPDUckdDlys	4	4
1055	RandXfFlang_DPFItdlyEmpty	4	4
1110	Amplitude Follower	4	2
1111	Auto V/O Ducker	2	2
1112	Bigger Is Wider	2	2
1113	Fm Trem	2	2
1114	Eight Compressors	8	8
1115	Eight Noisegates	8	8
1116	Omnipressor (R)	2	2
1117	Perfect Trem	2	2
1118	PsychicDuck DSP A	4	2
1119	Eight Expanders	8	8
1120	Octal Trem	8	8
1121	Ramp Up/Down 8	8	8
1122	SemiClassic Squeeze	2	2
1123	Top 40 Compressor	2	2
1124	Tremolo Lux	2	2
1125	Comp(3bandFIR)_S	2	2
1126	Comp(3bandFIR) Quad	4	4
1127	Comp(4bandFIR)_S	2	2
1128	Comp(5bandFIR)_M	2	2
1130	5.1 Compression	6	6
1131	5.1 Compr>3 B ParEQ	6	6
1132	5.1 Comp(3bandFIR)	6	6
1133	5.1 HyperTremolo	6	6
1140	St.Compr > EQ45	2	2
1141	St Compr > EQ65	2	2
1142	St Comp_DP 8GraficEq	2	2
1210	Eight Band EQ	4	4
1211	Eight Band EQ8	8	8
1212	FilterBank15	2	2
1213	FilterBank20	2	2
1214	Octal*10 Grafic Eq	8	8
1215	Octal*5 Grafic Eq	8	8
1216	Quad*16 Grafic Eq	4	4
1217	Quad*8 Grafic Eq	4	4
1218	Stage Parametric	4	4

1219	Stereo*32 Grafic Eq	2	2
1220	2*32 Grafic Eq	2	2
1221	Threeband Eq's	8	8
1222	Threeband Eq's	4	4
1223	Threeband Eq_Q	4	4
1224	4*8 Grafic Eq	4	4
1226	8*8 Grafic Eq	8	8
1227	Five Band EQ	8	8
1230	5.1 4B Param Eq	6	6
1231	5.1 16*Grafic Eq	6	6
1232	5.1 DP 4B Param Eq	6	6
1240	DP_St.EQ45	2	2
1241	DP_St.EQ65	2	2
1242	DP Stereo8 Grafic Eq	2	2
1243	Quad DP 5 Band EQ	4	4
1310	A Nice Place !	2	4
1311	BeyondTheStars	2	4
1312	DontGoInTheCellar	2	4
1313	Doom Of Matrix	2	4
1314	Europa	2	4
1315	Galaxy Borders 2	2	4
1316	Gothica VROOOM	2	4
1317	Italo's Space	2	4
1318	MachineLife	2	4
1319	Onirica Ritmica	2	4
1320	Singularity	2	4
1321	Stratospherics	2	2
1330	2_5.1 A nice Place !	2	6
1331	2_5.1 Doom of Matrix	2	6
1332	2_5.1 Europa	2	6
1333	2_5.1Galaxy Borders2	2	6
1334	2_5.1 Gothica VROOOM	2	6
1335	2_5.1 Italo's Space	2	6
1336	2_5.1Onirica Ritmica	2	6
1410	'AllWays'PanFltr	2	4
1411	Cup Mute	2	2
1412	Dual Modfilters	2	2
1413	EZ Leslie	2	2
1414	Filter Bank Pan	2	4
1415	Eight Filters	8	8
1416	Four Filters	4	4



1417	Harmonic Enhance	2	2
1418	Mouth-a-lator Two	2	2
1419	OctaveBandFilterPan	2	4
1420	OrganicAnimation	2	2
1421	Perpetual Motion	2	4
1422	Sample/hold	4	4
1423	Sample/hold8	8	8
1424	Sequence Wa	2	4
1425	Simple Samp/Hold	2	2
1426	Sweep Filter	2	2
1427	Synthlike Filter	2	2
1428	Tight Bandpass Mod	2	4
1429	Two Band Crossover	2	4
1510	Auto Pitch Correct	2	2
1511	Clrmtn's NemWhipper	2	2
1512	External Correct	2	2
1513	NemWhipper Dual	2	2
1514	NemWhipper Stereo	2	2
1515	AutoPitchCorrect 4ch	4	4
1610	Character Shift 1>2	2	2
1612	F Of H Multi	4	4
1613	KG's ColorHall	2	2
1614	L<->R Long	2	2
1615	L>detune / R>reverb	2	2
1616	L_C_R Long	2	2
1617	L_C_R Short	2	2
1618	MicroPitch (+/-)	2	2
1619	Saxomaniac	2	2
1620	2 Voice Vox Reverse	2	2
1621	4 Reverbs (FoH)	4	4
1622	4 Softknee Comps	4	4
1623	FoH Fx Rack #1	4	4
1624	FoH Fx Rack #2	4	4
1710	Acoustic Gtr Rack	2	2
1711	Bass Rack	2	2
1712	Biomechanica	2	4
1713	CleanPreamp	2	2
1714	Fermilab	2	2
1715	Gerrys Bass 99	2	2
1716	Hexentanz	2	4
1717	In Ovo	2	4

1718	Jinn	2	4
1719	Parallel Pedalboard	2	2
1720	Piano (sustenido)	2	4
1721	Series Pedalboard	2	2
1722	Serpentine	2	4
1723	The Gyre	2	4
1724	Tom's Acoustic Gtr	2	2
1725	Twang Guitar	2	4
1726	Virtual Pedalboard	2	2
1727	White Queen	2	4
1728	Gilmour Dlys & Pan	2	2
1810	Arkham Distortion	2	4
1811	Atavachron	2	4
1812	Bejing Dragons D	2	4
1813	Bejing Dragons V	2	4
1814	Biomechanica Three	2	4
1815	British Smash	2	4
1816	Carsultyal Steel	2	4
1817	Cyber Twang	2	4
1818	Desert Oboe	2	4
1819	DesertDemon	2	4
1820	DesertMorpher	2	4
1821	Distortion Preamp	2	2
1822	Dunwich Distortion	2	4
1823	Electronica Gtr	2	4
1824	Fifth Dominion	2	4
1825	Flange + Verb	2	2
1826	Fuzack	2	4
1827	Fuzz 2002	2	4
1828	GodSaveTheQueen	2	2
1829	Gothic	2	4
1830	Harpshift	2	2
1831	Jeff Thing	2	4
1832	Mercury Cloud	2	2
1833	Multishift + Verb	2	2
1834	Polychorus	2	2
1836	Rshift Displacement	2	2
1837	Splatter Guitar	2	4
1838	Square Tubes	2	4
1839	SRV	2	4
1840	Swamp Guitar	2	4

1841	TarantulaSlap	2	4
1842	TarantulaTrem	2	4
1845	Trevor's Gtr	2	4
1846	Tribal Bass	2	2
1847	Will-o-the-wisp	2	4
1848	WonderfulBirds	2	4
1910	Biomechanica Two	2	2
1911	Bit Desert 1	2	4
1912	Bit Desert 2	2	4
1913	BitDecimationPreamp	2	2
1914	Bits Cruncher	2	4
1915	Bits Smasher	2	4
1916	Black Queen	2	4
1917	Chorus Smear	2	4
1918	Cloudfuzz	2	4
1919	Eel Guitar	2	2
1920	First Dominion	2	4
1921	FuzzPreamp	2	2
1922	Grieving Tube	2	2
1923	Grundulator	2	2
1924	Harmonicon	2	4
1925	Larynxfuzz	2	2
1926	Mr. Hyde	4	4
1927	OverdrivePreamp	2	2
1928	Pandemonium	2	2
1929	Paradigm Shift	2	2
1930	Pedal Shift	2	4
1931	Ringworld	2	4
1932	Satellites	2	4
1933	Second Dominion	2	4
1934	Siderialfuzz	2	2
1935	Squiggle Guitar	2	2
1936	Third Dominion	2	4
1937	Turbulence	2	4
1938	Wideshift	2	4
1939	5.1 Pandemonium	6	6
2010	DesertVoices	2	2
2011	Eurhetemec	2	4
2012	EZPolyfuzzBandelay	2	2
2013	GobiGuitar	2	4
2014	Horrormonics	2	2

2015	Hyperstrings	2	2
2016	Polyonyx	2	4
2017	PolyReverse	2	4
2018	PolyRingPre	2	4
2019	QuadPolyfuzz	2	4
2020	SlidingOnRazors	2	4
2021	Surgery	2	4
2022	WaPolyReverse	2	4
2110	AcousticAmbience1	2	4
2111	AcousticAmbience2	2	4
2112	Ambient Guitar 1	2	4
2113	Ambient Guitar 2	2	4
2114	ColorSlapGuitar	2	4
2115	Crafty Ensemble	2	4
2116	Crafty Ensemble2	2	4
2117	DesertDistortion	2	4
2118	Jhaniikest	2	4
2119	Oobleck	2	4
2120	Outer Reaches	2	4
2121	Pianistick	2	4
2122	PolytonalSurround	2	4
2123	Pulse Guitar	2	4
2124	Quadchorus	2	4
2125	QuadpanSlap	2	4
2126	Quadswell	2	4
2127	RoundRobin	2	4
2128	Solid Traveller	2	4
2129	SurroundGuitar	2	4
2130	TexturalGuitar	2	4
2131	WitchesDance	2	4
2132	With Warts In	2	4
2133	2_5.1 Ambient Gtr 1	2	6
2134	2_5.1 Ambient Gtr 2	2	6
2210	Bad Acid Jumble	4	4
2211	Evil Distortion	2	4
2212	Gerrys Mangler	4	4
2213	Growl	2	2
2214	Low Res Digital	4	4
2215	DigiDegradar	2	2
2216	Dist-o-rt Maniac	2	2
2217	Inharmonic Trance	2	2

2218	SuperAmbientDlys	2	2
2310	Bigger And Brighter	2	2
2311	Class A Distortion4	2	2
2312	Compress & De-ess	2	2
2313	Compress Highs Only	2	2
2314	Dirty Master Box 4	2	2
2315	Fatten The Bass	2	2
2316	Grunge Compress	2	2
2317	Manual Tape Flange2	2	2
2318	Masderring Lab 22	2	2
2319	Radio Check	2	2
2320	Radio Compress	2	2
2410	Midi Harmony	2	2
2411	MIDI Monitor	4	4
2412	Midi Pitch Delay	4	4
2413	Midi Resonance	4	4
2414	Midi Sine Ring Mod	4	4
2415	MIDI Tremolo	4	4
2416	MidiHarmonixExtract	2	4
2417	MidiWaveformImpose	2	4
2418	QuadOffsetTrem	4	4
2419	SetNoteRezon	4	4
2610	Circles&Ellipses	4	4
2611	LMS Filter	2	2
2612	Mixer's Toolbox #1	2	2
2613	Mixer's Toolbox #2	2	2
2614	Mixer's Toolbox #3	2	2
2615	Mixer's Toolbox #4	2	2
2616	Simple Quadmixer	4	4
3009	8 mono fx	8	8
3010	8chorus+4verb	4	4
3011	BB Delayz	2	2
3012	Big Squeezolo	2	2
3013	Crystal Morpher	2	4
3014	Dervish	2	2
3015	Detune & Reverb	2	2
3016	Dr. Jekyll 2	4	4
3017	Easternizer	2	2
3018	FatFunkVocalFilter	2	2
3019	Glitterous Verb	2	2
3020	Guitar Mania	2	2

3021	GunnShift	2	2
3022	Inst Process	2	2
3023	L=verb R=pitch	2	2
3024	Larynx Delay	2	2
3025	Mods/comps/filters	2	2
3026	Moon Solo	2	2
3027	Pickers Paradise	2	2
3028	Roey's Delay + Shift	2	2
3029	Roey's Verb + Rack	2	2
3030	SeqWah ChorVerb	2	4
3031	Space Station	2	2
3032	St Delayed Flanger	2	2
3033	St.Phaser & Reverb	2	2
3034	Texture 47	2	4
3035	ToneCloud	2	2
3036	Treatment Two	2	4
3037	Trem + RingPong	2	2
3038	Tremolo Rack	2	2
3039	Waterized	2	2
3040	5th Place	2	2
3050	6 Chorusdlys & Verb	2	2
3051	6 Vox Flanger & Verb	2	2
3052	Comb Room	2	2
3053	Comp/Eq/Micro/Verb	2	2
3054	Guitar Magic	2	2
3055	Sax Eq_Cmpr_VintDly	2	2
3056	Vox Channel Strip	2	2
3057	Super Ch Strip 48K	2	2
3058	Super Ch Strip 96K	2	2
3210	4CompEq_2VintDuckDlyEmpty	8	8
3211	Acoustic Gtr Mondo	6	6
3212	Delays Suite	6	6
3213	DShif_VDly_Hall	6	6
3214	Dtune_VDly_Hall_EQ	8	8
3215	Mpitch_Pcm70_PanDly	6	6
3216	Plate_Inv_VintDly_Ch	8	8
3217	Q Delays_Ambience	6	6
3218	Virtual Rack 1	8	8
3219	Virtual Rack 2	8	8
3220	Virtual Rack 3	8	8
3221	VoxPro_Vdly_Chorus	6	6

3222	Compr>3band Eq 8ch	8	8
3223	CrWrlds2+SPlt+AMSDMX	6	6
3230	Angel Echos+St.Plate	4	4
3231	Bandtaps+CrsSpOBrian	4	4
3232	BrassPlt+1210Chorus	4	4
3233	ClrmntnDlys+EMTplate	4	4
3234	CrWrlds2+AMSDMX1580S	4	4
3235	MattFatRoom+VintDlysheadm	4	4
3236	MicroPitch+Room#24	4	4
3237	TapdlyPlex+BlackHole	4	4
3310	Amplitude Panner	4	4
3311	Auto Panner	4	4
3312	AutoFMPan_Verb	2	4
3313	AutoPanVerb	2	4
3314	Circle Panner	2	4
3315	Fly-by	2	4
3316	FM Panner	2	2
3317	FM Panner_S	2	2
3318	Gyro-X-Pattern	4	4
3319	Gyroscope	2	2
3320	GyroscopicField	4	4
3321	JoystikPanner	4	4
3322	Octave Panner	2	4
3323	Q_TriggPan	2	4
3324	Quad Circle	4	4
3325	Quad GhostCircle	2	4
3326	QuadCircleMod	2	4
3327	Simple Panner	2	2
3328	Squish/SquashPan	4	4
3329	Stereo Panner	2	2
3330	3D CircleDelay	2	2
3331	Rotator	8	8
3410	808 Rumble Tone	2	2
3411	Beatbox Reverb	2	2
3412	Drum Chamber	2	2
3413	Drum Filter	2	2
3414	Drum Flanger	2	2
3415	Drum Flutters	2	2
3416	Firecracker Snare	2	2
3417	Group Claps	2	2
3418	Liquid Toms	2	2

3419	Nerve Drums	2	2
3420	NoizSnareBrightener	2	2
3421	Nonlinear#1	2	2
3422	PercussBoingverb	2	2
3423	Ring Snareverb	2	2
3424	Small Drumspace	2	2
3425	Sonar Room	2	2
3426	Stereo Delays	2	2
3427	Swept Band Delay	2	2
3428	Techno Clank	2	2
3429	The Ambience Kit	2	2
3430	Tight Snare Verb	2	2
3431	Vibra Pan	2	2
3432	WeKnowBeetBoxTrtMe	2	2
3433	Wide Room	2	2
3434	4 Your Toms Only	2	2
3510	'Pure Phase' Phaser	8	8
3511	'Static' Phaser	2	4
3512	Band Phaser	2	4
3513	CBM Phaser	2	2
3514	Envelope Phaser	4	4
3515	ManualPhasers	4	4
3516	ManualPhasers8	8	8
3517	One Way Phaser	2	4
3518	Quad Phaser	4	4
3519	Random Phaser	2	4
3520	Samp & Hold Phaser	4	4
3521	Samp & Hold Phaser8	8	8
3522	Sci-Fi Phaser A	2	2
3523	Sci-Fi Phaser B	2	2
3524	StereoizingPhaser	2	2
3525	Techno Phaser	2	2
3526	TrueStereoPhaser	2	2
3527	Envelope Phaser8ch	8	8
3810	Bell Constr. Kit	2	2
3812	Headphone Filter	2	2
3813	Noise Cancellor	2	2
3814	TimeSqueeze(R)	2	2
3815	Walkie Talkie	2	2
3816	Woosh Maker	2	2
3817	16mm Projector	2	2



3818	Scratchy 33 RPM	2	2
3910	Drums-o-Tronica	2	2
3911	Electronix	2	4
3912	GrooveSync Delay	2	2
3913	Plex-o-tronica	2	2
3914	Pulsewave	4	4
3915	Swing Pong Delay	2	2
3916	Techno Rave	4	4
3917	TrigLFO Filter Bank	3	4
3918	TrigLFO Flanger	4	2
3919	TrigLFO Pan, Trem	4	4
3920	TrigLFO St ModFilterEmpty	4	2
3921	TrigLFO St Phaser	4	2
3930	5.1 Freeze 2 Beats	6	6
3931	5.1 Freeze the Beat	6	6
3932	Freeze 2 Beats	2	2
3933	Freeze the Beat	2	2
3934	2_5.1 PlexFltrTaps	2	6
4010	2_5.1 Alley Slap E/rEmpty	2	6
4011	2_5.1 Booth E/r	2	6
4012	2_5.1 Med Room E/r	2	6
4013	2_5.1 Piano Room E/rEmpty	2	6
4014	2_5.1 Small Room E/rEmpty	2	6
4015	2_5.1 Stadium E/r	2	6
4016	2_5.1 Stage E/r	2	6
4017	2_5.1 Vox Chmbr E/r	2	6
4018	2_5.1 DynamicSpread	2	6
4019	2_5.1 Spread	2	6
4030	2_5.1 Ac Gtr Space	2	6
4031	2_5.1 Bright Gym	2	6
4032	2_5.1 Cathedral	2	6
4033	2_5.1 Chamber Choir	2	6
4034	2_5.1 Drums Room	2	6
4035	2_5.1 Empty Arena	2	6
4036	2_5.1 Fat Drums	2	6
4037	2_5.1 Majestic PlateEmpty	2	6
4038	2_5.1 Sax Plate	2	6
4039	2_5.1 Surr Slap BackEmpty	2	6
4040	2_5.1 Tight Booth	2	6
4041	2_5.1 Tight Snare	2	6
4042	2_5.1 Tunnel	2	6

4043	2_5.1 Vocal Hall	2	6
4044	Surr Black Hole	2	6
4110	5.1 Cathedral	6	6
4111	5.1 Choir Hall	6	6
4112	5.1 Concert Hall	6	6
4113	5.1 Drums Room	6	6
4114	5.1 Jazz Club	6	6
4115	5.1 Lead Guitar	6	6
4116	5.1 Percussion Room	6	6
4117	5.1 Piano Hall	6	6
4118	5.1 Rich Chamber	6	6
4119	5.1 Sax Hall	6	6
4120	5.1 Snare Plate	6	6
4121	5.1 Stadium	6	6
4122	5.1 Theater Stage	6	6
4123	5.1 Vox Plate	6	6
4124	5.1 EzDiffusor	6	6
4125	5.1 EzDiffChorus	6	6
4126	5.1 EzModVerb	6	6
4131	5.1 Choir Chamber	6	6
4132	5.1 Classic Plate	6	6
4133	5.1 Concert Hall 96	6	6
4134	5.1 Drums Booth	6	6
4135	5.1 Drums Room	6	6
4136	5.1 Gregorian ChurchEmpty	6	6
4137	5.1 Metal Tunnel	6	6
4138	5.1 Sax Chamber	6	6
4139	5.1 Snare Chamber	6	6
4140	5.1 Surr Slap Back	6	6
4141	5.1 Vox Bright PlateEmpty	6	6
4142	5.1 Vox Hall	6	6
4143	5.1 Dynamic Spread	6	6
4150	5.1 Choir Chmbr E/r	6	6
4151	5.1 Concrete Lrg E/rEmpty	6	6
4152	5.1 Drums Booth E/r	6	6
4153	5.1 Far Walls E/r	6	6
4154	5.1 Hard Walls E/r	6	6
4155	5.1 Lg Envirnmnt E/rEmpty	6	6
4156	5.1 Md Envirnmnt E/rEmpty	6	6
4157	5.1 Piano Room E/r	6	6
4158	5.1 Sax Stage E/r	6	6

4159	5.1 Sm Envirnmnt E/rEmpty	6	6
4160	5.1 Stage E/r	6	6
4161	5.1 Wood Walls E/r	6	6
4170	5.1 140 EMT Plate	6	6
4171	5.1 Reverb Units	6	6
4208	3B X-over Hall 96	2	2
4209	4B x-over Hall	2	2
4210	Ambience	2	2
4211	Brass Plate	2	2
4212	Deep Space	2	2
4213	Drum Plate	2	2
4214	Drums Room	2	2
4215	Gated Inverse Snare	2	2
4216	Gated Plate	2	2
4217	Hall > Bandpass	2	2
4218	Inverse Snare	2	2
4219	Inverse	2	2
4220	Inverse > Bandpass	2	2
4221	Large Room	2	2
4222	Living In The Past	2	2
4223	Living Room	2	2
4224	L/C/R mics Room	2	2
4225	Piano Hall	2	2
4226	Plate > BandPass	2	2
4227	Rich Chamber	2	2
4228	Room > Bandpass	2	2
4229	Sax Chamber	2	2
4230	Sax Plate	2	2
4231	Slap Plate	2	2
4232	Snare Plate	2	2
4233	Tiled Room	2	2
4234	Vocal Chamber	2	2
4235	Vocal Hall	2	2
4236	Vox Plate	2	2
4237	Wide Hall	2	2
4240	Hall_Peaking Fltr	2	2
4241	Chamber>Glide Dlys	2	2
4242	Flanged EchoVerb	2	2
4243	Large Room2	2	2
4244	Loneliness	2	2
4245	Really Large Room	2	2

4246	Reverb Suite	2	2
4247	Sharp Verb	2	2
4248	Small Chamber	2	2
4249	Strings Room	2	2
4250	New Room	2	2
4310	Barking Chamber	2	2
4311	Boston Chamber	2	2
4312	Chamber2	2	2
4313	Dream Chamber	2	2
4314	Italo's Chamber	2	2
4315	Medium Chamber	2	2
4316	MetallicChamber	2	2
4317	Toonchamber	2	2
4410	Arena Soundcheck	2	2
4411	Beeg Garage	2	2
4412	Big Hall 2	2	2
4413	Environment#28	2	2
4414	Masterverb Hall	2	2
4415	Masterverb Hall 1	2	2
4416	Masterverb Hall 2	2	2
4419	Matt's Fat Room	2	2
4420	Roomy Hall	2	2
4421	SplashVerb	2	2
4422	3B X-over Hall	2	2
4510	Chorus & Plate	2	2
4511	EMT-style Plate	2	2
4512	Metallic Plate	2	2
4513	Reverb A2	2	2
4514	Sizzler Plate	2	2
4515	Springverb	2	2
4516	St.Plate+Chorus	2	2
4517	Stereo Plate	2	2
4518	Swept Plate	2	2
4610	EarlyRefections	2	2
4611	LatticeArray	2	2
4612	Preverberator	2	2
4613	SimpleDiffusor	2	2
4614	Slap Nonlinear	2	2
4615	StereoDiffusor	2	2
4616	Ultratap 1	2	2
4617	Ultratap 2	2	2

4709	AcousticRoom	2	2
4710	Big Room	2	2
4711	Blue Box Verb	2	2
4712	Bob's New Room	2	2
4713	Denny's Echoroom	2	2
4714	Der Verb	2	2
4715	Drews Dense Room	2	2
4716	Funny Gated Room	2	2
4717	Gated Water Snare	2	2
4718	LatticeVerb	2	2
4719	LRMS Reverb	2	2
4720	Masterverb Room 2	2	2
4721	ReelRoom	2	2
4722	Ridiculous Room	2	2
4723	Room#24	2	2
4724	Slight ChorusRoom	2	2
4725	UK Ambience	2	2
4726	UK Bright	2	2
4727	UK Nonlinear	2	2
4728	Unreelroom	2	2
4729	Wooden Mens Room	2	2
4810	Bass Space	2	2
4811	Close Nonlinear	2	2
4812	Drew's Double Closet	2	2
4813	Drew'sSmallRoom	2	2
4814	FIR Glass Shower	2	2
4815	Gym Shower	2	2
4816	ImpWaveVerb	2	2
4817	MasterverbRoom1	2	2
4818	Medium Booth	2	2
4819	New Air	2	2
4820	Pantry	2	2
4821	Shifting Booth	2	2
4822	Small Ambience	2	2
4823	Soft'n Small Room	2	2
4824	Stereo Mic's W/Room	2	2
4910	AcousticRoom	2	4
4911	Basilica	2	4
4912	Catacomb	2	4
4913	ChoralEchoVerb	2	4
4914	Cumulo-nimbus	2	4

4915	DetuneRoom#28	2	4
4916	DiffuseRoom#24	2	4
4917	EchoRoom	2	4
4918	Gravity Verb	2	4
4919	ImpWaveQuad	2	4
4920	Joystik>verb	4	4
4921	Klaus' Church	2	4
4922	Mix>FourSidedVerb	4	4
4923	Mix>Quadroom#10	4	4
4924	Mix>Quadroom#24	4	4
4925	MonkRoom	2	4
4926	Panped>Quadroom#10	4	4
4927	Panped>Quadroom#24	4	4
4928	QuadRoom#24	4	4
4929	QuadVerb/Crossfeed	4	4
4930	SaxRoom	4	4
4931	StringRoom	2	4
4932	SurroundRoom#28	2	4
4933	Toonchamber_Q	2	4
4934	Unreelroom_Q	2	4
4935	4 Room#16 Verbs	4	4
4936	FourSidedVerb	4	4
5010	Adaptive Reverb	2	2
5011	AlienShiftVerb	2	2
5012	Black Hole	2	2
5013	ChoralWindVerb	2	2
5014	ChoruspaceO'Brien	2	2
5015	Echospace Of God	2	2
5016	Flutter Booth	2	2
5017	Gated Gong Verb	2	2
5018	Ghost Air	2	2
5019	GloriousChrsCanyon	2	2
5020	GloriousFIngCanyon	2	2
5021	Horrors	2	2
5022	Jurassic Space	2	2
5023	Kickback	2	2
5024	Phantom & Reverb	2	2
5025	PillowVerb	2	2
5026	Pop Up	2	2
5027	Ramp Verb	2	2
5028	Resonechos	2	2

5029	Reverse Nonlinear	2	2
5030	Reverserize Hall	2	2
5031	Sizzle Verb	2	2
5032	SplashVerb Maxsweep	2	2
5033	Square Tremolo Verb	2	2
5034	Swell Verb 9	2	2
5035	Tremolo Reverb	2	2
5036	Wormhole	2	2
5037	Zipper Up	2	2
5038	Verb>ArpResonators	2	2
5040	PlexDiff Ambience	2	2
5041	Plex Diffusor	2	2
5042	PlexDiffVerb	2	2
5109	5.1 Ring Modulators	6	6
5110	Bell Ringer	2	2
5111	Envelope Ring Mod	4	4
5112	Evil Ring Dist	4	4
5113	Modulating Ring Mod	4	4
5114	TRUE RingMod	4	4
5115	One Way Ring Mod	2	2
5410	4_Detuners	4	4
5411	4_PitchShift	4	4
5412	4_ReverseShift	4	4
5413	4_ReverseTetra	4	4
5414	5.1 5ths & 8ves	6	6
5415	5.1 Detuned ArpeggioEmpty	6	6
5416	5.1 MicroPitchShift	6	6
5417	5.1 Pitch Shifters	6	6
5418	Detuners 8ch	8	8
5419	PitchShift 8ch	8	8
5420	ReverseShift 8ch	8	8
5421	ReverseTetra	2	2
5422	5.1 Shifted Echoes	6	6
5423	ChordConstruct'nKit	2	2
5424	10v Arpegg Thick	2	2
5425	5.1 Trem Detuners	6	6
5426	Dr.Jekyll 1	4	4
5427	120BPM ShifterDelay	2	2
5428	5ths&Oct Multiply	2	2
5429	Dual H910s	2	2
5430	4 IntervalShifts	2	2

5431	Dubbler	2	2
5432	Etherharp	2	2
5434	IntervalicShift_S	2	2
5435	Large Poly Shift	2	2
5436	LevitationShift	2	2
5437	MultiShift_4	4	4
5438	MultiShift_8mod	2	2
5439	Organizer	2	2
5440	PolytonalRythym	2	2
5441	Stereo Backwards	2	2
5442	Vibrato_S	2	2
5443	Wammy_s	2	2
5444	Warm Shift	2	2
5450	CC Shifter 4v	2	2
5451	5.1 Reverse Shifters	6	6
5452	5.1 Mod Detuners	6	6
5453	Mod_Detuners 8ch	8	8
5454	St.ModDetuners	2	2
5510	4_DiatonicShift	4	4
5511	5.1 C Maj Key Arps	6	6
5512	5.1 C Maj Pent Arps	6	6
5513	5.1 C Min Clusters	6	6
5514	5.1 DiatonicShiftersEmpty	6	6
5515	5.1 Maj Key Chords	6	6
5516	5.1 Min Pentatonic	6	6
5517	Diatonic +3rd+5th	2	2
5518	Diatonic +3rd+7th	2	2
5519	Diatonic +4th+6th	2	2
5520	Diatonic +5th+Oct	2	2
5521	Diatonic +5th-4th	2	2
5522	Diatonic +5th-oct	2	2
5523	Diatonic +/- Oct	2	2
5524	Diatonic Thesaurus	2	2
5525	Diatonic Trio	2	4
5526	DiatonicShift_8	4	4
5527	Diatonic_8mod	2	2
5528	M_4DiatonicShift	4	4
5529	Stepped Dshifter	2	4
5530	CC D_Shifter4v	2	2
5709	Aliens	2	2
5710	Angelic Echos	2	2



5711	Bubbly Freq Flange	4	4
5712	Chim-Chiminee	2	2
5713	Crystal 5th Caves	2	2
5714	Crystal Caves	2	2
5715	Crystal Heaven	2	2
5716	Crystal Oct & 5ths	2	2
5717	Crystal Octaves	2	2
5718	Crystal Orbits	2	2
5719	Crystal Pad 2	2	2
5720	Crystal Sevenths	2	2
5721	Crystal Worlds 2	2	2
5722	CrystalGyroscope	2	2
5723	Dinosaurs	2	2
5724	Doppler Pass	2	4
5725	DuckedCrystals	2	2
5726	Fake Pitch Shift II	2	2
5727	FreqShift W/Delay	4	4
5728	FreqShift W/Delay8	8	8
5729	Genesis II	2	2
5730	Latin Cathedral	2	2
5731	ReverseTetra	2	2
5732	Shift To Nowhere	2	4
5733	Steeplechase	2	2
5734	StringTrio	2	4
5735	Scary Movie & Verb	2	2
5736	Ominous Morphing	2	2
5737	Lunatics	2	2
5740	5.1 Reverse Crystals	6	6
5741	Adventure	2	2
5742	Diamond Rain	2	2
5743	GloriousAngelics	2	2
5809	5.1 ResoMachine	2	6
5810	Alert (401)	2	2
5811	Doorbell (403)	2	2
5812	Flintlock	2	2
5813	Himalayan Heights	2	2
5814	Jet Fly By	2	2
5815	Jettison (405)	2	2
5816	Locomotive	2	2
5817	Mortar Shells	2	2
5818	Sonar (409)	2	2

5819	Stereocopter (410)	2	2
5820	Stormwatch	2	2
5821	TankAttack (411)	2	2
5823	Ufo (413)	2	2
5830	5.1 Flintlock	2	6
5831	5.1 Helicopter	2	6
5832	5.1 Jet Flyby	2	6
5833	5.1 Mortar Shells	2	6
5834	Big Badaboum	2	2
5835	Violin Bow Bounce	2	2
5910	Bass Balls	2	2
5911	Inversion LFO	2	4
5912	Mess With Stereo	2	2
5913	Quad Spatializer	2	4
5914	QuadDlyBasedPan	2	4
5915	Squish / Squash	4	4
5916	TruePhase Delay	2	2
5917	3-D PhaseInverter	2	4
6109	Arabian Collangette	2	2
6110	Eel Drums 2	2	2
6111	External Hats	2	2
6112	FM TimbreFactory	2	4
6113	Heen	2	2
6114	Jan&Jeff	2	2
6115	Rise Or Fall Osc	2	4
6116	Samp/Hold FM Lab	2	4
6117	Timbre Factory	2	4
6210	Audio Test Set	4	4
6211	Click Test	4	4
6212	Dig Sig Gen 4	2	2
6214	Phase Test	4	4
6216	Oscillator 1k 0vu	2	4
6217	20>20 Audio Sweep	2	4
6310	Choir+Diffchorus	2	2
6311	Choir+Diffchorus 2	2	4
6312	Choir+Verb	2	2
6313	Choir+Verb 2	2	4
6314	Colortaps+Verb	2	2
6315	Combtap+Diffchorus	2	2
6316	Diffchorus+Delay	2	2
6317	Diffchorus+Delay 2	2	4

6318	Mercury Cloud 2	2	2
6319	Salamanders D	2	4
6320	Salamanders V	2	4
6321	Tapdelay Plex	2	2
6322	Tapdelay Plex 2	2	4
6323	Tapdelay+Diffchor 2	2	4
6324	Tapdelay+Diffchorus	2	2
6325	Tapdelay+Verb	2	2
6326	Tapring Plex	2	2
6327	Tapring Plex 2	2	4
6330	2_5.1 Mercury Cloud2	2	6
6331	Dream Salamanders	2	2
6332	Plato's Dream	2	2
6333	Pleasure Pad	2	2
6408	2in4out	4	8
6409	5.1 Metered Thru'	6	6
6410	ChromaticTuner	2	2
6411	Dither	4	4
6412	Metronome	2	2
6413	Midi Modulator	2	2
6414	Midi Remote Cntrller	2	2
6415	Musicians' Calc	2	2
6416	Quadmixer	4	4
6417	Send/Return	4	4
6418	Switch*8	8	8
6419	Universal Matrix	2	2
6420	Verb Tester	2	2
6421	White Noise	2	2
6510	140 EMT Plate	2	2
6511	893 Undulator	2	2
6512	AMS DMX 1580S	2	2
6513	DynoMyPiano1380S	2	2
6514	H3000 Verby Chorus	2	2
6515	H3000BreathingCanyonEmpty	2	2
6516	Hand Flanger	4	4
6517	Omnipressor (R)	2	2
6518	Pcm70 Concert Hall	2	2
6519	Pcm70 Sax Hall	2	2
6520	RMX Simu Ambience	2	2
6521	Stereo Undulator	2	2
6522	Tape Echo	2	2

6523	TC2290	2	2
6524	TC2290 Dyn Chorus	2	2
6525	TC2290 Dyn Flanger	2	2
6526	TC2290 Dyn Long Dly	2	2
6527	Univibe	2	2
6528	1210 chorus	2	2
6530	Dimension D	2	2
6531	1980s Chorus	2	2
6532	H3000 FunctionGenrtrEmpty	2	2
6533	Underwater	2	2
6534	Circular Delays	2	2
6535	DEP5_alg6	2	2
6536	Pan Delays	2	2
6537	2xTC2290s	4	4
6610	Blues Heart	2	2
6611	Clean Chords	2	2
6612	Dream Strings	2	2
6613	Drums Treatment	2	2
6614	Electric Ladyland	2	2
6615	Fjord Guitar	2	2
6616	In Yer Face Vocals	2	2
6617	LA Studio Axe	2	2
6618	Lead Tone Poem	2	2
6619	Metal Fatigue	2	2
6620	Monster RACK !	2	2
6621	One Time Rhyno	2	2
6622	Pentatonic Delight	2	2
6623	Psychedelic Vocals	2	2
6624	Rock Vocals Rack	2	2
6625	Searing Lead	2	2
6626	Smpled Drums Rack	2	2
6627	Tablas Baba	2	2
6628	Tale From The Bulge	2	2
6629	1980s Rack	2	2
6640	Midi Chorus_Flanger	2	2
6641	Midi Compressor	2	2
6642	Midi Diatonic Shift	2	2
6643	Midi Dual TT Delay	2	2
6644	Midi FM Tremolo	2	2
6645	Midi Reverb 12	2	2
6646	Midi Reverb 8	2	2

6647	Midi Reverse Shift	2	2
6648	Midi Ring Mod	2	2
6649	Midi Shifter_Whammy	2	2
6650	Midi St Dynamic Dly	2	2
6651	Midi St Micropitch	2	2
6652	Midi St Phaser	2	2
6654	Midi St Moddetuners	2	2
6655	Midi St XF Delays	2	2
6656	Midi XF4v ModulationEmpty	2	2
6660	Midi VirtRack #1	2	2
6661	Midi VirtRack #2	2	2
6662	Midi VirtRack #3	2	2
6663	Midi VirtRack #4	2	2
6664	Midi VirtRack #5	2	2
6665	Midi VirtRack #6	2	2
6666	Midi VirtRack #7	2	2
6670	Midi VirtRack #9	2	2
6671	Midi VirtRack #10	2	2
6672	Midi VirtRack #11	2	2
6673	Midi VirtRack #12	2	2
6674	Midi VirtRack #13	2	2
6675	Midi VirtRack #14	2	2
6710	B-vox Delays+verb	2	2
6711	B-vox Pitch+verb	2	2
6712	DualVoxProcess	2	2
6713	Phased Voxverb	2	2
6714	Proximityverb	2	4
6715	Vocal Chorusdelays	2	2
6716	VocalverbTwo	2	2
6717	Voice Disguise	2	2
6718	Voice Processor	2	2
6719	Vox Double+Slap	2	2
6720	Vox Shimmer	2	2
6721	Voxplate / Chorus	2	2
6722	VoxProcess_S	2	2
6810	CreamyVocoderAlpha	2	2
6811	CreamyVocoderBeta	2	2
6910	80s Guitar Rig	2	2
6911	Asbakwards	2	4
6912	Brain Loops	2	2
6913	Dynamic Worm	2	2

6914	Flaedermaus	2	2
6915	Ghosties	2	2
6916	Liquid Sky	2	2
6917	PolySwirl Tap	2	2
6918	September Canons	2	2
6920	ToddsPedalShiftVerb	2	2
6921	Descant	2	2
7010	Empty Program	4	4
7012	Inter-DSP Send	4	4
7013	Interface Modules	4	4
7014	Patch Instruct	4	4
7015	Tempo Dly_Lfo Jig	2	2
7016	Tempo_Verb Jig	2	2
7017	TimerDly Jig	2	2
7018	X-DSP Contr Send	2	2
7110	Airplane Background	2	2
7111	Clock Radio	2	2
7112	Fries With That?	2	2
7113	Office Intercom	2	2
7114	Sound Truck	2	2
7115	Talking Dashboard	2	2
7210	Bullhorn	2	2
7211	CB Radio	2	2
7212	Cellular Phone	2	2
7213	Crazy Dialer	2	2
7214	Long Distance	2	2
7215	Megaphone	2	2
7216	More's Code	2	2
7217	Off Hook!	2	2
7218	Public Address	2	2
7219	Real Dialer	2	2
7220	Shortwave Radio	2	2
7221	Traffic Report	2	2
7310	Ducked Delays	2	2
7311	Easy Chorus	2	2
7312	Easy Phaser	2	2
7313	Long Delay W/ Loop	2	2
7410	Basic Stereo Echo	2	2
7411	Big Church	2	2
7412	Classroom	2	2
7413	Crypt Echo	2	2

7414	Infinite Corridor	2	2
7415	Kitchen Reverb	2	2
7416	Plate Reverb	2	2
7417	Tape Reverb	2	2
7418	Tile Men's Room	2	2
7419	Union Station Verb	2	2
7510	Big Movie	2	2
7511	Boom Box	2	2
7512	Fake Call-in	2	2
7513	Page Three!	2	2
7514	Real Call-in	2	2
7515	TV In Next Room	2	2
7516	45 RPM Oldie	2	2
7610	Cousin It	2	2
7611	Cussing It	2	2
7612	Elves	2	2
7613	Fantasy Backgrounds	2	2
7614	Magic Echo	2	2
7615	Morph To Magic	2	2
7616	Singing Mouse	2	2
7617	Trolls	2	2
7710	Backwards	2	2
7711	Can't Carry Tune	2	2
7712	Dynamic Stereo	2	2
7713	Go Crazy	2	2
7714	Plug Puller Pro	2	2
7715	Round & Round	2	2
7716	Solo Zapper Pro	2	2
7810	Awfultones	2	2
7811	Brightener	2	2
7812	Easy Timesqueeze	2	2
7813	Hiss Eliminator	2	2
7814	Hum Eliminator	2	2
7815	Sfx Filter/Compress	2	2
7816	Simple Compressor	2	2
7817	Simple Equalizer	2	2
7818	Stereo Simulator	2	2
7819	Stereo Spreader	2	2
7820	Super Punch	2	2
7821	1 KHz Oscillator	2	2
7822	Three Band Compress	2	2

7910	Artoo Chatter	2	2
7911	C3P-Yo!	2	2
7912	Lasers!	2	2
7913	Martian Rock Band	2	2
7914	Robot Band	2	2
7915	Theremin	2	2
7916	Tribbles	2	2
8010	'Max' Stutter	2	2
8011	Big Voice Pro	2	2
8012	Chipmunks	2	2
8013	Doubletalk	2	2
8014	Fast Voice Process	2	2
8015	Mega-Dragey	2	2
8016	Nervous Talker	2	2
8017	Triplets	2	2
8018	Voice Process Pro	2	2
8019	We're A Big Crowd	2	2
8020	We're A Small Crowd	2	2
8110	Aerobics Teacher	2	2
8112	Funny Voices	2	2
8114	General Robotics	2	2
8115	Heartbeat	2	2
8117	Manic Depressive	2	2
8119	Split Personality	2	2
8120	The Buzz	2	2
8121	Vocal Sweeper	2	2
8210	Bubbles	2	2
8211	Computer Room	2	2
8212	Digital Hell	2	2
8213	Droning Spaces	2	2
8214	Echoes of Doom	2	2
8215	Room Tones	2	2
8216	Stereo Next Door	2	2
8217	Swinging Reverb	2	2
8310	Bass Enhance Kit	2	2
8311	Big Woosh	2	2
8312	Brightener	2	2
8313	Delay Kit	2	2
8314	Dialog Cleaner	2	2
8315	Dizzy	2	2
8316	Dynamic Flanger	2	2



8317	Dynamic Shifter	2	2
8318	Emotion Meter	2	2
8320	Harmonic Mangler	2	2
8322	Humdinger	2	2
8323	Split Delays	2	2
8324	Swept Resonance	2	2
8411	33 RPM (new)	2	2
8412	45 RPM New	2	2
8413	Early 78 Record	2	2
8414	Laptop Speaker	2	2
8415	Line Extender	2	2
8416	Lousy MP3	2	2
8417	Mandolin	2	2
8418	Medical Monitor	2	2
8419	Puppy Blender	2	2
8420	Speaking Harp	2	2
8421	Telephone Suite	2	2
8422	TV Suite	2	2
8423	Universal Radio	2	2
8510	Broken Mic	2	2
8511	Car Window	2	2
8512	Cave Echoes	2	2
8513	Concrete Place	2	2
8514	Endless Oddity	2	2
8515	EqEcho & Verb	2	2
8516	Fantasy	2	2
8517	In/Out Room	2	2
8518	Next Room	2	2
8519	P.A. Echo	2	2
8520	Radio Mic	2	2
8521	Reflections	2	2
8522	Room/Phone	2	2
8523	Sci-Fiction Dlys	2	2
8524	Tape Echo/Deep Hall	2	2
8525	Thick Ambience	2	2
8526	Thru AM Airwaves	2	2
8527	Thru Phone 1	2	2
8528	Thru Phone 2	2	2
8529	Tomb/TV Speaker	2	2
8530	Waves Place	2	2
9101	Digital Delay	2	2

9102	Vintage Delay	2	2
9103	Tape Echo	2	2
9104	Mod Delay	2	2
9105	Ducked Delay	2	2
9106	Band Delay	2	2
9107	Filter Pong	2	2
9108	MultiTap	2	2
9109	Reverse	2	2
9110	Looper	2	2
9201	Chorus	2	2
9202	Phaser	2	2
9203	Q-Wah	2	2
9204	Flanger	2	2
9205	ModFilter	2	2
9206	Rotary	2	2
9207	TremoloPan	2	2
9208	Vibrato	2	2
9209	Undulator	2	2
9210	RingMod	2	2
9301	Diatonic	2	2
9302	Quadravox	2	2
9303	HarModulator	2	2
9304	MicroPitch	2	2
9305	H910 H949	2	2
9306	PitchFlex	2	2
9307	Octaver	2	2
9308	Crystals	2	2
9309	HarPeggiator	2	2
9310	Synthonizer	2	2
9401	Hall	2	2
9402	Room	2	2
9403	Plate	2	2
9404	Spring	2	2
9405	DualVerb	2	2
9406	Reverse Reverb	2	2
9407	ModEchoVerb	2	2
9408	Blackhole	2	2
9409	MangledVerb	2	2
9410	TremoloVerb	2	2
9411	DynaVerb	2	2
9412	Shimmer	2	2

9501	UltraTap	2	2
9502	Resonator	2	2
9503	EQ Compressor	2	2
9504	SpaceTime	2	2
9505	Sculpt	2	2
9506	CrushStation	2	2

## Safety Information

- Before powering up the unit, check that the voltage selector on the back panel is set correctly.
- Do not remove any covers or panels from the unit when the power is connected.
- No operator access to the internals of the unit is permitted; servicing must be performed by qualified personnel only
- The unit must not be operated with a damaged or ungrounded power cord.
- Suitable ventilation must be provided for the unit at all times. In particular, the rear vents must not be obstructed. It is best if there is an inch or more clearance between the top of the H9000 and the bottom of the units above and below.

## Limited Warranty

The Eventide H9000 unit covered by this warranty is built to exacting quality standards and should give years of trouble-free service. If you are experiencing problems which are not cleared up in this manual, your recourse is this warranty.

### **What the Warranty Does and Does Not Cover**

Eventide Inc. warrants the above-identified unit to be free from defects in workmanship and material under normal operation and service for a period of one year from the date of purchase, as detailed below.

At our discretion within the warranty period, we may elect to repair or replace the defective unit. This means that if the unit fails under normal operation because of such defect, we will repair the defective unit at no charge for parts or labor. We also assume a limited responsibility for shipping charges, as detailed below.

**The warranty does not extend beyond repair or replacement as stated herein and in no event will we be responsible for consequential or incidental damages caused by any defect, and such damages are specifically excluded from this warranty. Our sole obligation is to repair or replace the defective unit as described herein.**

The warranty DOES NOT COVER any damage to the unit regardless of the cause of that damage. The unit is a complex piece of equipment that does not react well to being dropped, bounced, crushed, soaked or exposed to excessively high temperatures, voltages, electrostatic or electromagnetic fields.

If the unit is damaged for these or similar causes, and the unit is deemed to be economically repairable, we will repair it and charge our normal rates.

The warranty DOES NOT COVER shipping damage, either to or from Eventide. If you receive a new unit from us in damaged condition, notify the carrier and us; we will arrange to file an insurance claim and either repair or exchange the unit.

If you receive a new unit from a dealer in damaged condition, notify the dealer and the carrier.

If we receive the unit from you with apparent shipping damage, we will notify you and the carrier. In this case, you must arrange to collect on any insurance held by you or your carrier. We will await your instructions as to how to proceed with the unit, but we will charge you for all repairs on damaged units.

### **Who is Covered Under the Warranty**

The warranty applies to the original purchaser of a new unit from Eventide or an Authorized Eventide Dealer. Demo units are also covered by this warranty under slightly different circumstances (see below).

Units that are used, or have been used as part of a rental program, are not covered under any circumstances.

It is your responsibility to prove or to be able to prove that you have purchased the unit under circumstances which affect the warranty. A copy of your purchase invoice is normally necessary and sufficient for this.

If you have any questions about who is an Authorized Eventide Dealer, call us. Units with the serial number plate defaced or removed will not be serviced or covered by this warranty.

### **When The Warranty Becomes Effective**

The one-year warranty period begins on the day the unit is purchased from an Authorized Eventide Dealer or, if the unit is drop-shipped from Eventide, on the day shipped, plus a reasonable allowance for shipping delays. This applies whether or not you return your warranty registration form.

## **WARRANTY INFORMATION**

When we receive a unit, this is how we determine whether it is under warranty:

1. If the unit was shipped from our factory within the past calendar year, we assume that it is under warranty unless there is evidence to the contrary, such as its having been sold as used or rented, etc.
2. If the unit was shipped from our factory more than a calendar year ago, we assume it is not under warranty unless:
  - a) There is a warranty registration form on file showing that it has been purchased within the past year under appropriate conditions.
  - b) You send a copy of your purchase invoice indicating warranty status along with the unit.
3. If the unit was used as a demo, the warranty runs from the date that it was received by the dealer. The original purchaser gets the unexpired portion of that warranty.

When you send a unit for repair, you should indicate whether or not you believe it to be under warranty. If you do not say the unit is under warranty, we will charge you

for the repair and we will not refund unless the charge was caused by an error on our part. If you believe the unit to be under warranty and you do say it is but we disagree, you will not incur any charges until the dispute is resolved.

Reading the above, you can see that it is to your advantage to send in the warranty registration form when you purchase the unit. If we know who you are, we can send you updates and notifications, and advise you of our new products. It will also enable you to receive pre-shipment of certain parts.

### **Who Performs Warranty Work**

The only company authorized to perform work under this warranty is Eventide Inc., Little Ferry, New Jersey. While you are free to give personal authorization to anyone else (or to work on it yourself), we will not honor claims for payment for parts or labor from you or from third parties.

However, we and our dealers do try to be helpful in various ways. Our dealers will assist, usually without charge during the warranty period, in:

- a) Determining whether there is a problem requiring return to the factory, and
- b) Alleviating user error or interconnection problems that may be preventing the unit from operating to its full capability.

We are available for telephone consultation if the dealer is unable to assist.

If a part is found to be defective during the warranty period and you wish to replace it yourself, we will normally ship the part immediately at no charge, provided your warranty registration form is on file. We reserve the right to request that the defective part be returned to us.

### **Shipping Within the 50 United States**

You are responsible for getting the unit to our door at no cost to us. We cannot accept collect or COD shipments.

We will return the unit to you prepaid, at our expense, using an expeditious shipping method, normally United Parcel Service. In areas not served by UPS we will ship by US Mail.

If you are in a hurry and want us to use a premium shipping method (such as air express, next day air, etc.), be sure you tell us and agree to pay shipping charges collect. If you specify a method that does not permit collect or COD charges, remit sufficient funds to prepay shipping.

### **Shipping Outside the 50 United States**

If you purchased the unit from a dealer in your country, consult with the dealer before returning the unit.

If you wish to return the unit to us, please note the following:

1. The unit must be prepaid to our door. This means that you are responsible for all shipping charges, including customs brokerage and duties. When a unit is shipped to us it must be cleared through United States Customs by an authorized broker. You must make arrangements for this to be done. Normally, your freight forwarder has a branch in the United States, which can handle this transaction. We can arrange to clear incoming shipments for you.

If you want our assistance, you must notify us before shipping the unit for repair, giving full details of the shipment, and including a minimum of \$250.00 in US funds to cover the administrative and brokerage expenses. Any balance will be applied to the repair charges or refunded. If a balance is due to us, we will request a further prepayment.

2. All shipments will be returned to you collect. If this is impossible because of shipping regulations or money is due us, we will request prepayment from you for the appropriate amount.

3. All funds must be in US dollars. Payment may be made by check drawn on any bank in the US, or by telegraphic funds transfer to our bank. If you send US currency, be sure that it is sent by a method you can trace, such as registered mail. If you wish to pay by Letter of Credit, be sure that it affords sufficient time for work to be performed and the L/C negotiated, and that it is free from restrictive conditions and documentation requirements.

4. We reserve the right to substitute freight carriers. Although we will attempt to honor your request for a specific carrier, it is frequently necessary to select a substitute because of difficulties in communication or scheduling.

This warranty gives you specific legal rights and you may also have other rights, which vary from location to location.