

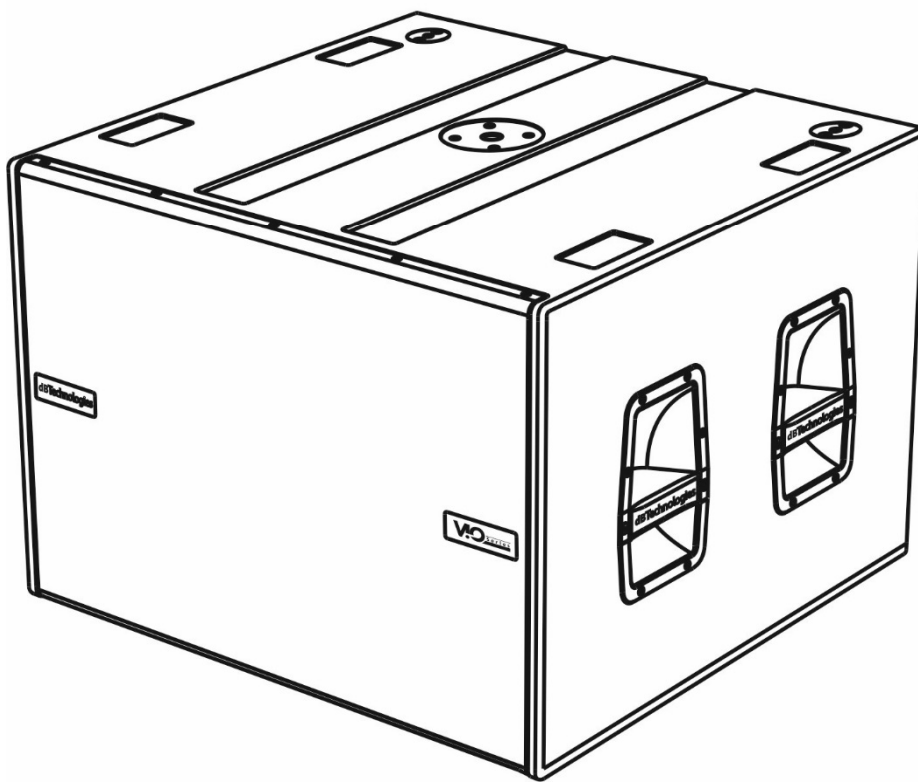

VIO S118R



Quick start user manual *Section 1*

The warnings in this manual must be observed together with the "USER MANUAL - Section 2".

Le avvertenze nel presente manuale devono essere osservate congiuntamente al "MANUALE D'USO - Sezione 2".

Die Warnungen in diesem Handbuch müssen in Verbindung mit der "BEDIENUNGSANLEITUNG - Abschnitt 2" beobachtet werden".

Les avertissements spécifiés dans ce manuel doivent être respectés ainsi que les "CARACTERISTIQUES TECHNIQUES - Section 2"

Las advertencias del presente manual se deben tener en cuenta conjuntamente con las del "MANUAL DEL USUARIO" - Sección 2".

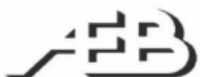

A.E.B. Industriale Srl Via Brodolini, 8 Località Crespellano 40053 VALSAMOGGIA BOLOGNA (ITALIA)
Tel +39 051 969870 Fax +39 051 969725 www.dbtechnologies.com info@dbtechnologies-aeb.com



Thank you for choosing a dBTechnologies Product!

VIO S118R is an active bass reflex subwoofer, designed for professional use, equipped with one 18" woofer (voice coil: 4"). The powerful DIGIPRO® G4 amplifier section, capable of handling up to 1600 W (RMS power), is controlled by a DSP, which can perform a detailed customization of the output sound of the subwoofer. In particular, thanks to the complete control interface, it is possible to accurately tune various types of configurations, like cardioid or end-fire. The RDnet connections allow in-depth remote control, thanks also to free available software (AURORA NET, dBTechnologies Composer). Professional accessories (like DRK-210 fly-bar and SWK-18 wheels kit) ensure easy set-up to create different configurations, completing live installations with VIO line-array series.

Check the site www.dbtechnologies.com for the complete user manual!

1) Unpacking

The box contains:

No. VIO S118R

No. 1 Mains cable with Neutrik® powerCON TRUE1 connector

No. 1 Fuse for 100-120V~ usage

This quick start and warranty documentation

2) Easy installation

The easy use in different configurations is guaranteed by:

- **handles [A]**, two for each side
- **pole-mount adapter [B]**, on the top, M20 threaded hole
- **pick points for DRK-210 fly-bar [C]** (in stacked installation)
- **amplifier control panel [D]**
- **threaded holes for SWK-18 wheels kit [E]**

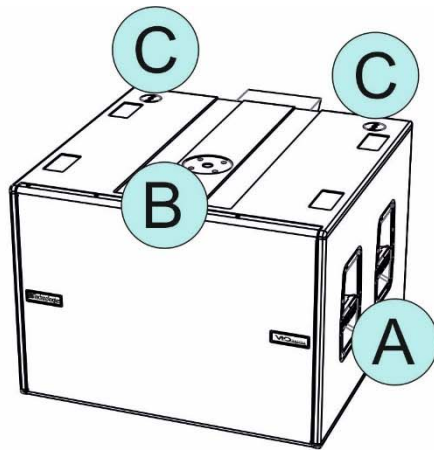

FRONT SIDE

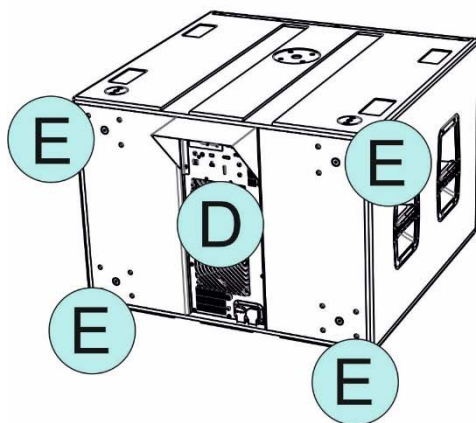

REAR SIDE

The main accessories are shown below. Please refer to the related instructions and complete manuals for further information.

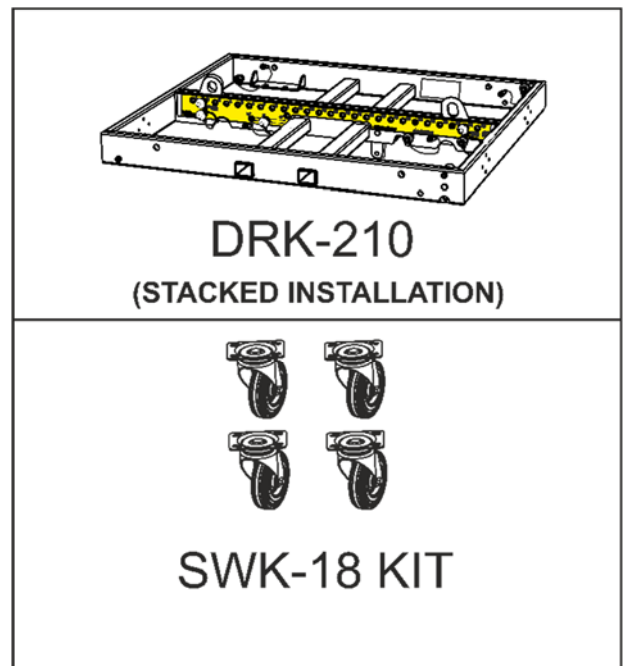

DRK-210
(STACKED INSTALLATION)

SWK-18 KIT

MAIN ACCESSORIES



The product and accessories must be handled by trained personnel only! The user is required to follow regulations and mandatory laws on safety of the country in which the product is used. Don't use handles and/or roping points to suspend VIO S118R!

3) First switch-on

The DIGIPRO G4 amplifier of VIO S118R is controlled by a powerful DSP. All the connections and controls are in the rear amplifier control panel:

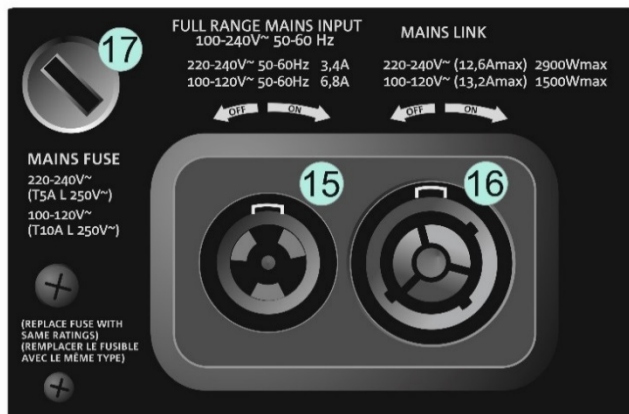
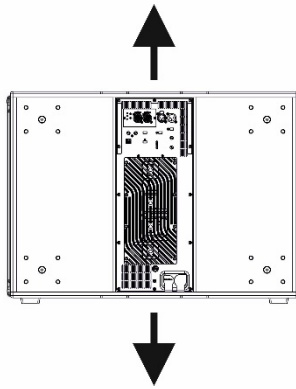
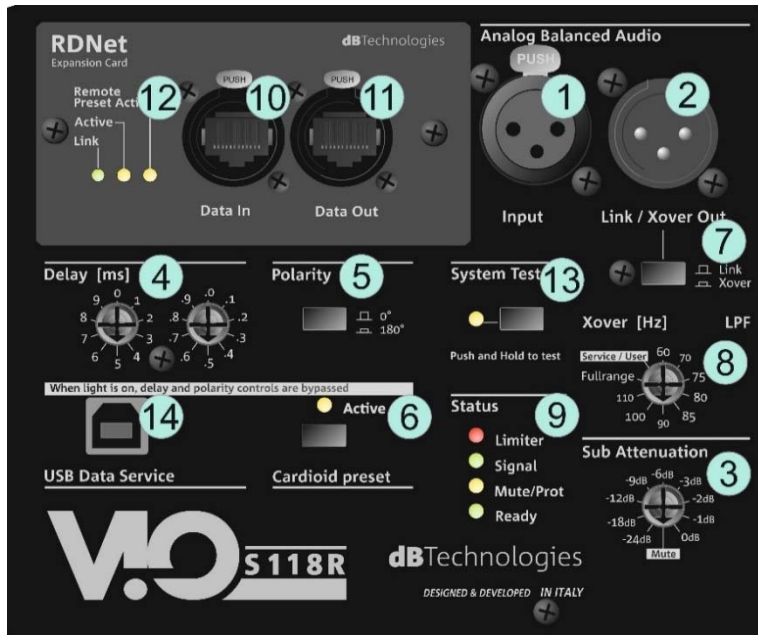

The subwoofer is supplied with a mounted fuse for operation within the 220-240V~ range. If you need to operate in the 100-120V~ voltage range:

- **Disconnect all connections, including the power supply**
- **Wait 5 minutes**
- **Replace the fuse with the one provided in the package for the 100-120V~ range**

- 1 – Input (balanced) connector
- 2 – Link/Xover Out (balanced) connector
- 3 – Subwoofer attenuation rotary control

VIO S118R

- 4 – Delay rotary controls
- 5 – Polarity switch
- 6 – Cardioid preset switch
- 7 – Link/Xover Out switch
- 8 – Xover LPF
- 9 – Status LEDs (Limiter, Signal, Mute/Protection, Ready)
- 10 – RDNet Data In
- 11 – RDNet Data Out
- 12 – RDNet status LEDs
- 13 – System test switch
- 14 – USB Data Service (USB-standard Type B)
- 15 – Full Range Mains input connector
- 16 – Mains Link connector
- 17 – Mains Fuse

a) Once you have properly set up the desired configuration (see also the VIO S118R complete user manual and accessories instructions for further information), connect the audio input (1). Set the Subwoofer attenuation (3) to 0 dB.

b) Connect the possible output direct link (2), and set the Link/Xover Out switch (7). If your choice is Xover, you can choose the LPF frequency with (8) Xover rotary. This filter does not affect the “Link” output.

c) Choose the Subwoofer Setup (Delay 4, Polarity 5) In cardioid configuration, please note that the cardioid preset switch (6), when active, bypass these controls.

d) In case of remote control, connect the Data Input (10) to the hardware remote controller (RDNet Control 2 or RDNet Control 8) with cables equipped with etherCON connectors. Then connect the Data Output (11) to the Data Input (10) of a possible second device, and so on. When the RDNet network is on and it has recognized the connected device, the LED “Link” (12) is on. The other LEDs (12) “Active” start blinking at the presence of data transmission, the “Remote Preset Active” advise that all the local controls set on the amplifier panel (level, DSP presets, etc.) are by-passed and controlled remotely by RDNet. In remote control it is essential the use of free dBTechnologies software (check the last revision on www.dbtechnologies.com):

- **AURORA NET,**

necessary for an in-depth control of different devices in remote connection;

- **dBTechnologies Composer,**

necessary for safety check and for the complete sound system design, particularly developed for VIO series.

e) Connect the power supply (15). Link the power to other subwoofer or modules (see Technical Data for further information) using mains link connector (16).

Check the complete user manual on www.dbtechnologies.com for further information about the system and available accessories.

Scarica il manuale completo da www.dbtechnologies.com per ogni ulteriore informazione sul sistema e sugli accessori disponibili.

Für weitere Informationen und verfügbares Zubehör lesen sie bitte die vollständige Bedienungsanleitung unter www.dbtechnologies.de.

Vérifiez le manuel de l'utilisateur complet sur www.dbtechnologies.com pour des informations complémentaires du système et des accessoires disponibles.

Compruebe el manual de usuario completo sobre www.dbtechnologies.com para la información adicional sobre el sistema y accesorios disponibles.

Technical Data

Speaker Type: Active bass-reflex subwoofer

Acoustical data

Frequency Response [-6 dB]: 35 Hz - Cut frequency
(crossover - dependent)

Frequency Response [-10 dB (HPF)]: 32 Hz

Max SPL (1 m): 139 dB

LF: 1 x 18"

LF Voice Coil: 4"

Crossover freq.: 60 to 110 Hz + full-range

Directivity: (omnidirectional) Cardioid with DSP

Amplifier

Amp Technology: Digipro® G4

Power supply: Full range with PFC

Amp Class: Class-D

RMS Power: 1600 W

Peak Power: 3200 W

Cooling: Passive (convection) and internal fan

Operating voltage:

100-240V~ 50-60 Hz (Full Range)

Processor

Controller: DSP, 32 bit

AD/DA converter: 96 kHz

Limiter: Peak, RMS, Thermal

Controls: Rotary Delay Control (0-9.9 ms, steps: 0.1 ms), switches (Link/Xover, Cardioid Preset, System test, Polarity), Sub Attenuation, Xover LFP

Input

Mains connections: PowerCON® TRUE1 In/link

Maximum number of subwoofer for each daisy chain power connection [mains input + mains link]: 1+3 VIO S118R** (220-240V~), 1+1 VIO S118R** (100-120V~)

Signal Input: (Balanced) 1x IN (female)

Signal Out: (Balanced) Link/Xover OUT (male)

RNET connectors: Data In / Data Out

USB connector: standard USB B-type (for SERVICE DATA)

Mechanics

Housing: Wooden box/black polyurea finish

Grille: Full metal (CNC machining)

Handles: 2 per side

Pole mount adapter: 1 on the top (M20 threaded hole)

Pick points (stack mode): yes (on top for DRK210)

Width: 720 mm (28.34 in)

Height: 530 mm (20.87 in)

Depth: 700 mm (27.56 in)

Weight: 47 kg (103.62 lbs.)



Scan with
your QR
Reader App to
download the
complete User
Manual

POWER SUPPLY SPECIFICATIONS (POWER ABSORPTION)

Draw at 1/8 of full power in average use conditions (*): 1.4 A (220-240V~) - 2.7 A (100-120V~)

Draw at 1/3 of full power in maximum use conditions ():** 3.4 A (220-240V~) - 6.8 A (100-120V~)

Power absorption with speaker turned on without signal (idle): 35 W

* INSTALLER NOTES: The values refer to 1/8 of full power, in average operating conditions (music program with infrequent or no clipping). It is recommended to consider them the minimum sizing values for any type of configuration.

** INSTALLER NOTES: The values refer to 1/3 of full power, in heavy operating conditions (music program with frequent clipping or activation of the limiter). We recommend sizing according to these values in case of professional installations and tours.

Download the complete user manual on:

www.dbtechnologies.com/EN/Downloads.aspx

EMI CLASSIFICATION

According to the standards EN 55103 this equipment is designed and suitable to operate in E5 Electromagnetic environments.

FCC CLASS A STATEMENT ACCORDING TO TITLE 47, PART 15, SUBPART B, §15.105

This equipment has been tested and found to comply with the limits for a Class A digital device, pursuant to part 15 of the FCC Rules.

These limits are designed to provide reasonable protection against harmful interference when the equipment is operated in a commercial environment.

This equipment generates, uses and can radiate radio frequency energy and, if not installed and used in accordance with the instructions, may cause harmful interference to radio communications.

Operation of this equipment in a residential area is likely to cause harmful interference in which case the user will be required to correct the interference at his own expense.

Changes or modifications not expressly approved by the party responsible for compliance could void the user's authority to operate the equipment.

WARNING: This equipment is compliant with Class A of CISPR 32. In a residential environment this equipment may cause radio interference.

WARNING: Make sure that the loudspeaker is securely installed in a stable position to avoid any injuries or damages to persons or properties. For safety reasons do not place one loudspeaker on top of another without proper fastening systems. Before hanging the loudspeaker check all the components for damages, deformations, missing or damaged parts that may compromise safety during installation. If you use the loudspeakers outdoor avoid spots exposed to bad weather conditions.

Contact dB Technologies for accessories to be used with speakers. dBTechnologies will not accept any responsibility for damages caused by inappropriate accessories or additional devices.

Features, specification and appearance of products are subject to change without notice.

dBTechnologies reserves the right to make changes or improvements in design or manufacturing without assuming any obligation to change or improve products previously manufactured.